

# VUpoint

## Dome Vandal-Proof P2P IP Camera



**Model: RVCM32W**



**Installation Guide**

**Language**      **Page**

**EN**

1

**FR**

25

**IT**

50

**ES**

71

# VUpoint

## Dome Vandal-Proof P2P IP Camera



**Model: RVCM32W**

EN



<http://VUpoint-P2P.riscogroup.com/How-to-Install/>

# Installation Guide

## **Safety Precautions**

These instructions are intended to ensure that the user can use the product correctly to avoid danger or property loss.

### **WARNINGS:**

- Installation or usage of this product that is not in accordance with the intended use as defined by the supplier and as described in the instructional materials can result in damage, injury, or death.
- Make sure this product is not accessible by children and those for whom operation of the system is not intended.
- All installation and operation should conform to your local electrical safety codes. The power shall conform to the requirement in the SELV (Safety Extra Low Voltage) and the Limited power source is rated 12V DC in the IEC60950-1.
- If the device is permanently connected to an electrical power supply, then the connection should include an easily-accessible disconnection device, such as a circuit breaker. Do not connect the two power supplying sources to the device at the same time; it may result in device damage!
- Do not ever attempt to repair your device by yourself, as doing so could result in damage, injury or death – always contact your installer / supplier agent for service.

### **CAUTIONS:**

- Make sure the power supply voltage is correct before using the camera.
- Do not drop the camera or subject it to physical shock.
- Do not touch sensor modules with fingers. If cleaning is necessary, use a clean cloth with a bit of ethanol and wipe it gently.
- Do not aim the camera lens at the strong light such as sun or incandescent lamp. The strong light can cause fatal damage to the camera.
- The sensor may be burned out by a laser beam, so when any laser equipment is being used, make sure that the surface of the sensor not be exposed to the laser beam.
- Do not place the camera in extremely hot, cold temperatures (the operating temperature should be between  $-10^{\circ}\text{C}$  ~  $+50^{\circ}\text{C}$ ).
- To avoid heat accumulation, good ventilation is required for a proper operating environment.
- While shipping, the camera should be packed in its original packing.

**NOTE:** We assume no liability or responsibility for all the fires or electrical shock caused by improper handling or installation. We are not liable for any problems caused by unauthorized modification or attempted repair.

## Introduction

RISCO Group presents VUpoint, a revolutionary live video verification solution which seamlessly integrates IP Cameras within RISCO's professional security systems. Powered by the RISCO Cloud (RISCO Application Server), VUpoint provides an unprecedented level of security and live video monitoring capabilities to monitoring stations and end-users alike. The RISCO dome indoor and outdoor IP Camera is an important part of this solution and is easily controlled through RISCO's intuitive Web and Smartphone applications.

## Features

- Plug & Play installation
- 1.3 Megapixel
- Color HD
- Day/Night
- IR LED Length 30m

## Components and Accessories

RISCO IP camera and mounting bracket:

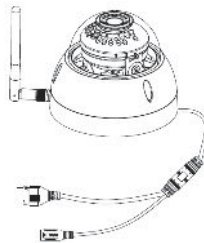

Installation guide:



# IP Camera Components and Dimensions

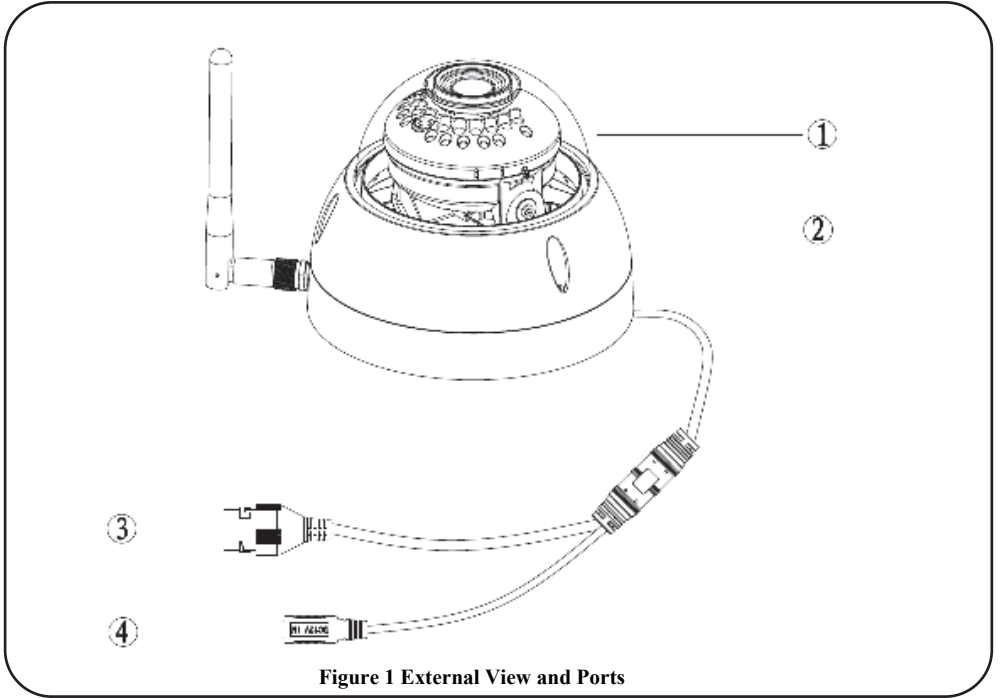
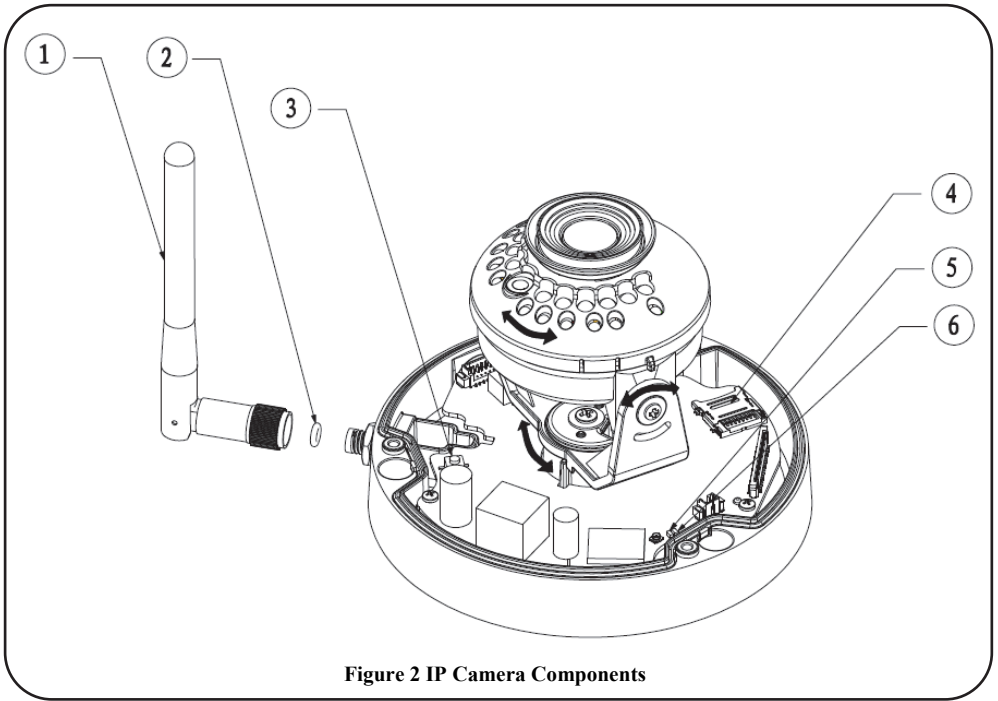

Figure 1 External View and Ports

Label	Name
1	Dome cover
2	Dome enclosure
3	Network port
4	Power port



**Figure 2 IP Camera Components**

Label	Name
1	Wireless antenna
2	Waterproof ring
3	Reset/ WPS (Wi-Fi Protected Setup) button
4	Micro SD card slot
5	Indicator light 1
6	Indicator light 2

**Note:**

- For reset (used to return the camera settings to factory default mode), long press for 15 seconds and then the light turns off
- For WPS (Wi-Fi Protected Setup), one quick press.

Indication	Status
Red light normally on	Booting
Green light slow flashing	IP Camera is not connected to the RISCO Cloud. Please check for internet connection and try to connect again by rebooting the IP Camera.
Green light quick flashing	WiFi smart config in progress, including WPS (WiFi Protected Setup), management frame and etc.
Green light normally on	IP Camera is successfully connected to the RISCO Cloud.
Red and green lights flash alternately	Device upgrade
Red light slow flashing	Network connection failure or disconnection after network connection success.
Red light quick flashing	Device malfunction, fail to boot up; alarm or SD card malfunction

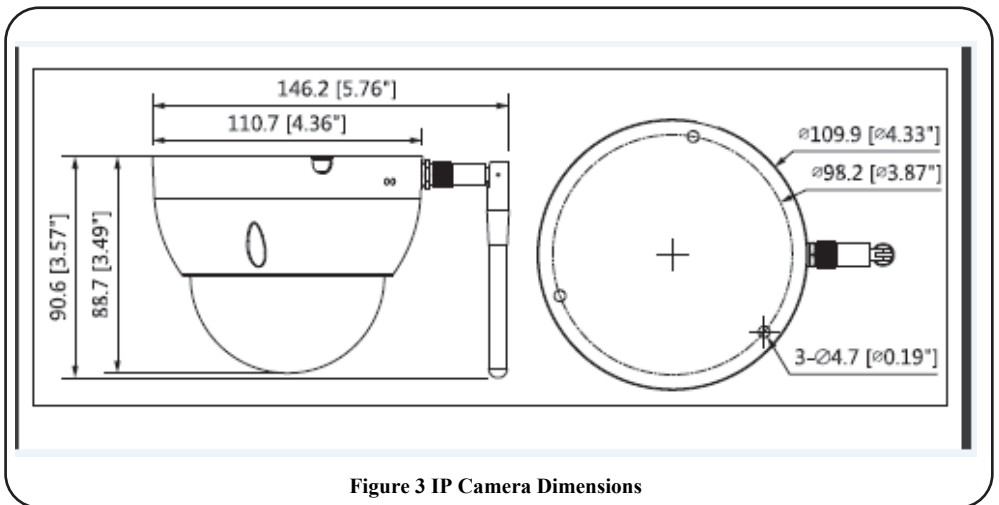

Figure 3 IP Camera Dimensions

## IP Camera Installation

After reading the installation instructions and before installing your IP camera, prepare a plan for mounting the IP camera at your protected site. Correct placement of your IP camera is crucial for optimal security-monitoring performance. First, determine which areas need to be protected and then map out the most optimal areas for installing your IP camera.

**IMPORTANT!** – Please make a record of the MAC address located on the box or on the back cover of the IP camera before installation. You may need it during the network connection stage.

MAC address



## Mounting the IP Camera

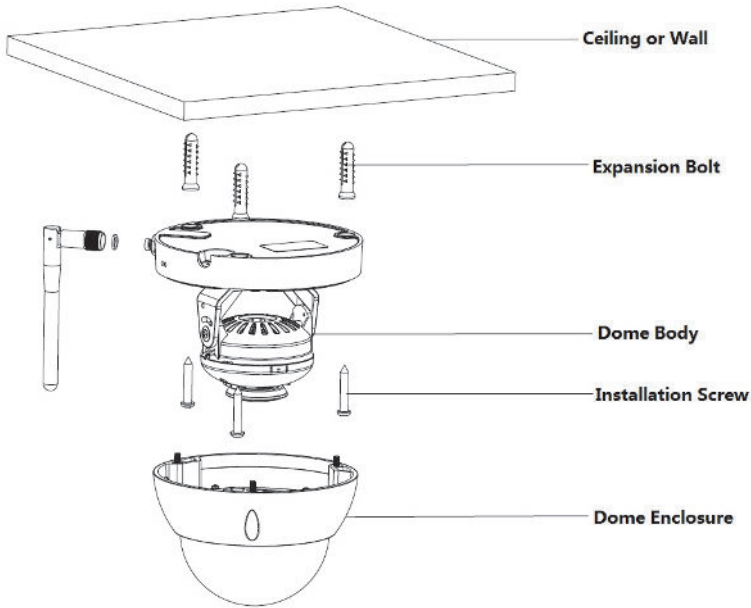

Figure 4 Mounting

**IMPORTANT-** Please make sure the installation surface can support at least 3 times the weight of the camera and the bracket.

Step	Description
1	Use the supplied hex wrench to open the dome enclosure by releasing the three inner hex screws.
2	Place the installation positioning template on the installation surface such as ceiling or wall.
3	Make holes in the installation surface according to the installation positioning template.
4	Insert the three expansion bolts into the holes.
5	Position the IP camera base over the holes
6	Use the screws from the accessories bag to secure the IP camera firmly.

Step	Description
	<ul style="list-style-type: none"> <li>• If you run the cable from the top of the installation surface, make an exit hole on the installation surface according to the installation positioning template.</li> <li>• If you run the cable from the side of the cable channel, it must go through the U-shaped channel on the dome support. Take out the cable from the side of the exit hole located on the support.</li> </ul>
7	Adjust the device installation support to the proper position and then run the cable through the exit hole located on the installation surface.
8	Align the TOP mark on the device installation support with that of the installation template.
9	Align the three screw holes in the device support with the three plastic expansion bolt holes in the installation template.
10	Firmly affix the three self-tapping screws to the three plastic expansion bolts.
11	Secure the dome body to the installation surface.
12	Hold both sides of the base of the rotation bracket, rotate horizontally along the axis and adjust the lens in the horizontal direction to the designated position.
13	<p>Hold the LED cover and rotate it vertically while adjusting the lens in the vertical direction to the designated position.</p> <p>If too tight to adjust, first loosen the fixed screws on both sides of the bracket (do not remove the fixed screws), then adjust the lens and tighten again the fixed screws.</p>
14	<p>While holding the LED cover, rotate it along the axis and adjust the lens image to the correct surveillance position.</p> <p><b>Range of lens:</b></p> <ul style="list-style-type: none"> <li>• vertical (0°~+64°)</li> <li>• horizontal (0°~+355°)</li> <li>• image rotation direction (0°~+355°)</li> </ul> <p><b>NOTE</b> – When rotation is at 64° in the vertical direction, please pay attention to the image rotation direction in order to prevent blockage of the IR light by the outer cover, as this can negatively influence the IR effect.</p>

## Powering-up the IP Camera

1. Connect power to the Power port on the IP camera.
2. Connect power to an electrical outlet. When the IP camera boots up, the GREEN power indicator light flashes.

## Connecting the IP Camera to the Network

The IP camera supports several network connection options including LAN and Wireless.

### Connecting to a LAN Network

Connecting the IP camera to a network using the LAN (Local Area Network) enables easy connection and setup with compatible APs (Access Points), e.g. gateway or router.

1. Connect the incoming network cable to the Network port on the IP camera.
2. The GREEN network indicator lights to indicate that your IP camera is now connected to the network. Continue as explained in Defining IP Camera Settings.

### Connecting to a Wireless Network using WPS

Connecting the IP camera to a wireless network using WPS (Wi-Fi Protected Setup) requires that the router supports WPS functionality.

---

**NOTE** – Some routers have a virtual button on their management software. (Refer to the router’s documentation for details about using its WPS functions).

---

1. Once the power cord is connected, wait for slow flashing GREEN network indicator.
2. Momentarily press the WPS button on the IP camera and hold down the WPS button on the router for 2 seconds. The GREEN network indicator light indicates that your IP camera is now connected to the network. Continue as explained in Defining IP Camera Settings.

## Connecting to a Wireless Network using the RISCO Cloud

Connecting the IP camera to a wireless network using the RISCO Cloud (RISCO Application Server) requires that you first connect the IP camera to the router via the LAN and then, from the RISCO Cloud Installer Application, define the IP camera settings and establish a wireless connection. Once a wireless connection has been established the IP camera can then be disconnected from the router and installed/mounted.

1. Connect the incoming network cable to the Network port on the IP camera.
2. The GREEN network indicator lights to indicate that your IP camera is now connected to the network. Continue as explained in Defining IP Camera Settings.

---

**NOTE** – Before disconnecting you must configure the wireless network through the RISCO Cloud.

---

3. Once a wireless connection has been established, you may disconnect the IP Camera from the router and install/mount it anywhere within the monitored area.

# IP Cameras and the RISCO Cloud Installer Application

The RISCO Cloud Installer Application provides an interface to your control panel from a local or remote PC via the Web. This enables you to add IP cameras and define camera and event alarm trigger settings.

**IMPORTANT** – A control panel must first be defined in RISCO Cloud in order to accept IP cameras and define camera settings (Refer to the RISCO Cloud Installer Application Manual)

## Defining IP Camera Settings

Once you have connected the IP camera to the network (refer to, Connecting the IP Camera to the Network) you can define the camera settings.

**To define IP camera settings:**

1. Log into the Installer Administration application using the Web page address supplied by your service provider and enter your user name and password.

**NOTE** – It is recommended to use Google Chrome or Mozilla Firefox to log into the Installer Administration application.

2. Select the Control Panels List link. The Control Panels List page is displayed.

The screenshot displays the 'Control Panels List' page. At the top, there are navigation tabs: Users List, Service Providers List, Control Panels List (selected), Statistics, Services Info, and Logout. Below these are sub-tabs: Customization, Configurations, Control Panels Groups (selected), Email & SMS Settings, SMS/Email Traffic, and Licenses. The main content area is titled 'Control Panels from group: All Panels (Page 1/4)'. It features a search bar: 'Find Control Panels where Last Name begins with [ ] [Find]'. Below the search bar is a table with the following data:

CP Login ID	Web Login ID	First Name	Last Name	Cell Phone	Provider (1st)	Account	Last Connected Time	Online?
TCONNECT203							7/17/2012 9:39:48 AM	No
2240000123							4/19/2012 5:34:47 PM	No
22400048768								Never
22400036472							5/14/2012 3:26:34 PM	No
22400000014							4/25/2012 9:00:11 AM	No
22400065764							5/21/2012 3:25:56 PM	No
22400000010							4/30/2012 1:11:16 PM	No
22400066013							5/2/2012 4:55:14 PM	No
22400000012							9/27/2012 1:01:38 PM	No
22400065725							9/19/2012 12:27:16 PM	No

Below the table is a 'New Customer' button and a note: 'Note: A new panel shall be automatically assigned to the currently selected CP group.' At the bottom right, there is a page size selector showing '10' and '>>>'.

Figure 5 Control Panels List Page

3. From the Control Panels List page, select the Control Panel you wish to view. The Control Panels Update page is displayed.

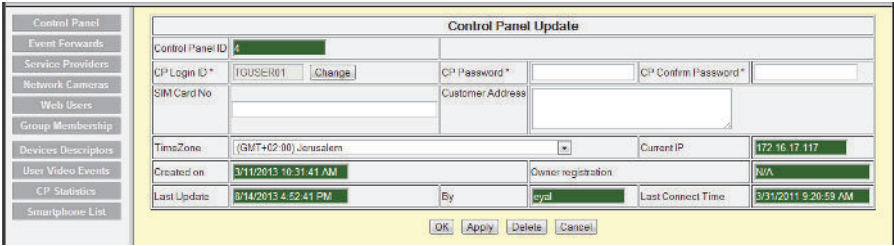

**Figure 6 Control Panel Update Page**

4. Click the Network Cameras link in the left-hand column; the IP Camera List page is displayed.

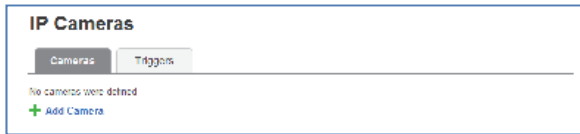

**Figure 7 IP Cameras List**

5. Click Add Camera; the Add Camera dialog box is displayed.
6. Select the RISCO P2P Camera type.

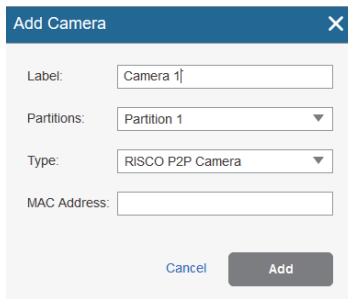
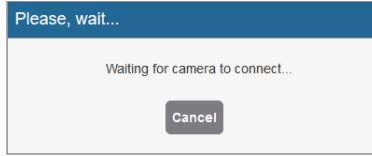

**Figure 8 Add Camera**

7. Define the following fields in the Add Camera dialog box.

Field	Description
<b>Label</b>	Enter a name for the camera
<b>Partitions</b>	Select the partition(s) from the list of defined partitions
<b>Type</b>	Choose the RISCO P2P Camera type (for ONVIF or Generic camera type settings, refer to the RISCO Cloud Installer Application Manual)
<b>MAC Address</b>	Enter the MAC address into this field. The MAC address (media access control address) is the unique identifier assigned to the IP camera for communications on the physical network. <b>NOTE:</b> The MAC address is case sensitive and should be entered exactly as it is shown on the box or on the back cover of the IP camera, e.g. AA:BB:CC:DD:EE:FF

8. Click Add; the following message is displayed.



**Figure 9** Waiting for camera to connect message

If the “Connect to WiFi” message is displayed, go straight to step 8.

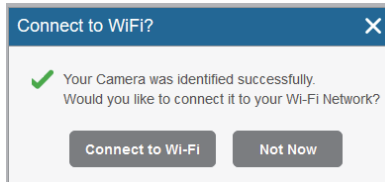

**Figure 10** Connect to WiFi message

9. Select one of the following options:

**Connect to Wi-Fi** – to establish a wireless network connection (go to step 9 to connect the IP camera to the wireless network).

**Not Now** – to maintain IP Camera connection using a LAN network connection (skip the wireless network connection steps 10, 11 and 12 and connect the IP camera to the LAN network).

10. If you selected the “Connect to Wi-Fi” option, a list of available wireless networks is displayed.

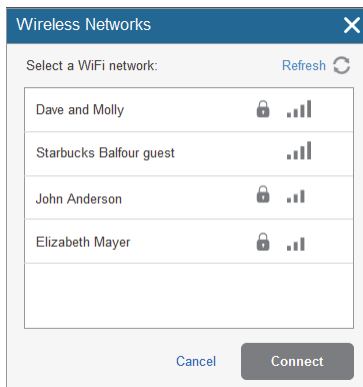

**Figure 11** List of available wireless networks

11. Select a wireless network from the available list and click Connect.

**NOTE** – If your network is password protected, a password must be entered into the displayed password screen.

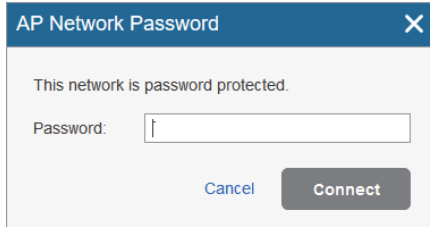

**Figure 12 AP Network Password**

- Click Connect to establish the wireless connection (Refer to Connecting to a Wireless Network using the RISCO Cloud); the following success message is displayed.

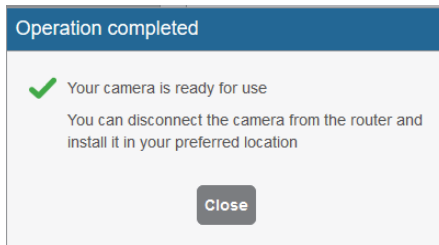

**Figure 13 Operation Completed**

- Once the “camera is ready for use” message is displayed, click Close. The defined IP camera is displayed in the IP Cameras page.

**NOTE** – Once a wireless connection has been established, don’t forget to disconnect the IP camera Ethernet cable from the router.

## IP Cameras

Label	Partition	Type	MAC Address	Wi-Fi	Actions
Main Entrance cam	Lobby Floor	RISCO	00-10-5A-44-12-B5	Connected	
Front yard cam	Lobby Floor, Storage Rooms	RISCO	00-10-2B-36-11-18	Connect	
Lobby cam	Lobby Floor	Generic	11-10-5A-44-12-B5	Connect	
Living Room	Storage Rooms	ONVIF	07-10-5A-4A-28-B6	Connected	
Second Floor north cam	Storage Rooms	ONVIF	00-10-5A-44-12-B5	Connected	
Basement	Sun Microsystems	RISCO	03-10-5A-44-12-B5	Connected	

**Figure 14 IP Camera List**

**NOTE** – You also have the option to edit  or delete  the selected IP camera.



Click the FW Action button below to check if the firmware is up-to-date.

## IP Cameras

Cameras Triggers

---

+ Add Camera

Label	Partition	Type	MAC/IP Address	Wi-Fi	Actions
Cube - Office	Partition 1	RISCO P2P Camera	3C:EF:8C:DF:6C:59	Risco-Guest	  

**Figure 15 Firmware Update**

The newer Firmware version will be displayed in the screen that opens, if applicable.

Firmware Update
✕

Current FW version: 2.400.0000.2.R

Newer FW version: 2.400.0000.3.R

FW update state: You can initiate the update manually.

Update FW

Close

**Figure 16 Newer Firmware Version**

## Defining Camera Trigger Settings

Any event from the following list can be defined to trigger an alarm.

Partition Events			
Fire Alarm	Panic Alarm	Medical Alarm	Alarm
Full Arm	Part Arm	Disarmed	Duress
Tamper	24 HR-X Alarm	Water Alarm	Gas Alarm
Environ. Alarm	No Motion Alarm	Exit Alarm	Low Temperature
Detector Events			
Alarm	Zone Bypassed	Zone Un-bypassed	Zone Tamper

**To define camera trigger settings:**

1. From the Control Panel Cameras page, click the Triggers tab, the Camera Triggers List page is displayed.

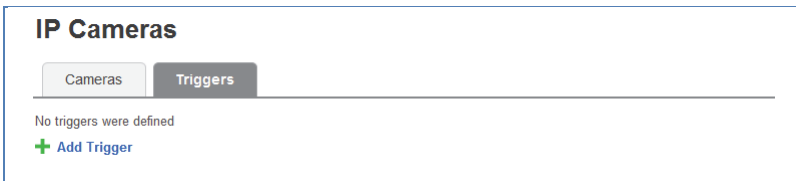

**Figure 17 Camera Triggers List**

2. Click Add Trigger; the Add Triggers dialog box appears.

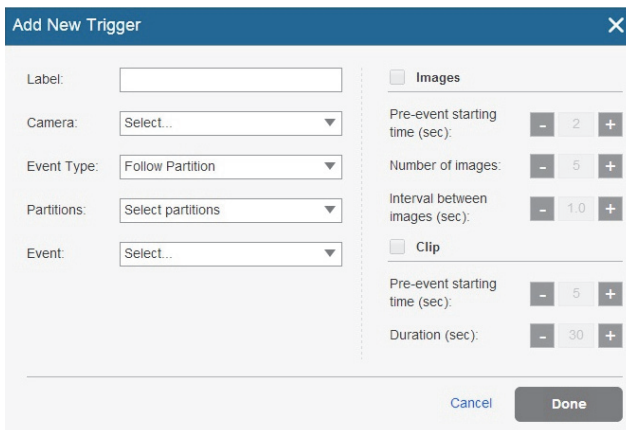

**Figure 18 Add Trigger**

3. Define the following fields in the Add Trigger dialog box:

Field	Description	Event Type
<b>Label</b>	Enter a name for the camera trigger	Partition and Detector events
<b>Camera</b>	Choose a camera from the list	Partition and Detector events
<b>Event Type</b>	Choose an event type from the list	Partition and Detector events
<b>Event</b>	Choose the event from the list, e.g. alarm, duress, etc.	Partition and Detector events

Additional fields are displayed in the Add Trigger dialog box according to the event type that you selected (see examples below for Partition and Detector event types).

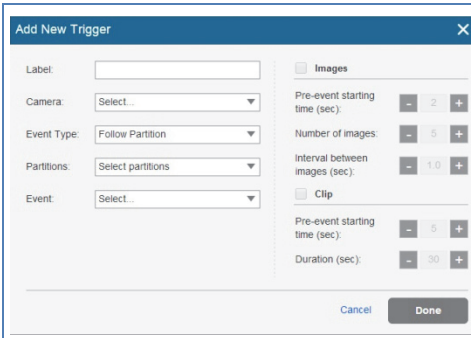

Figure 19 Add Partition Event Trigger

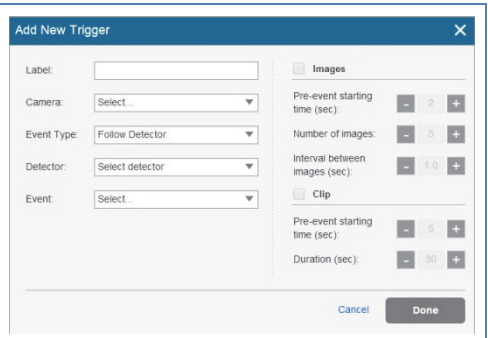

Figure 20 Add Detector Event Trigger

4. Define the following fields in the Add Trigger dialog box according to the event type that you selected.

Field	Description	Event Type
Partition(s)	Select the partition(s) from the list. <b>NOTE</b> – Only partitions associated with the camera are displayed.	Partition events only
Detectors	Select the detector from the list	Detector events only

5. Define the following image (still) and clip (video) definitions:

Field	Description
Images (still)	<b>Pre-event starting time (sec)</b> – time, before the actual event occurred, to start displaying still images. <b>Number of images</b> – number of still images to display. <b>Interval between images (sec)</b> – time required between each still image.
Clips (video)	<b>Pre-event starting time (sec)</b> – time, before the actual event occurred, to start displaying video clip. <b>Duration (sec)</b> – total duration of the video clip <b>NOTE</b> – These fields are currently locked and the default parameters cannot be changed.

**NOTE:** To be able to record video clips, make sure to insert an SD Card and then power down/up the camera.

- Once finished, click Done. The defined camera trigger is displayed in the Camera Triggers List page.

## IP Cameras

The screenshot shows the 'Triggers' tab in the IP Cameras section. It features a '+ Add Trigger' button and a table with the following data:

Label	Event	Camera	Camera Operations	Actions
Lobby floor alarm	Partition - Lobby Floor Alarm Follow	Street cam North	3 images, 10 seconds clip	
Storage Tamper	Partition - Storage Rooms Tamper Follow	Street cam South	1 image	
Lobby Arming	Detector - Lobby South-East Arm Follow	Lobby main cam	5 images, 20 seconds clip	

A 'Duplicate' button is visible below the table.

Figure 21 Camera Triggers List

**NOTE** – You also have the options to edit , create a duplicate , or to delete the selected camera trigger.

**IMPORTANT** – No two camera triggers can be defined as identical. If a camera trigger is duplicated, the event, camera or both definitions must be changed.

## Advanced Settings

For security reasons, measures have been taken to minimize the risks of hacking by restricting access to the IP Camera. However, in some cases, it is necessary to modify the default IP Camera settings according to requirement in the field. This is performed by experienced installers with special permission to access the IP Camera settings.

### To Access the IP Camera Settings

- Click the "..."/>

The screenshot shows the 'Cameras' tab in the IP Cameras section. It features a '+ Add Camera' button and a table with the following data:

Label	Partition	Type	MAC/IP Address	Wi-Fi	Actions
Cube - Office	Partition 1	f (	██████████	Risco-Guest	FW

Figure 22 IP Cameras Settings

The following screen appears.



**Figure 23 Enable UI/CGI Option**

2. Select the UI/CGI checkbox.
3. Click Save.

The installer is now provided with access to the Web interface of the IP Camera for a duration of one hour. Open an Internet browser and enter the IP address of the camera. By Default, the Username and Password for the IP Camera login is “admin” and “\_AdmiN\_+ IP Camera MAC address” (for example, AdmiN\_AABBCCDDEEFF).

---

**NOTE:** After one hour, access to the camera will be disabled.

---

## **Connecting to a Local Network Video Recorder (NVR)**

The installer can connect the IP Camera to a local NVR. The installer must determine the IP Address of the IP Camera and configure it as an ONVIF camera in the NVR. In addition, the installer must enter the IP Camera’s credentials. By Default, the Username and Password for the IP Camera login is “admin” and “\_AdmiN\_+ IP Camera MAC address” (for example, \_AdmiN\_AABBCCDDEEFF). The same credentials are used for the ONVIF camera.

The installer can now also access the live stream from the IP Camera.

---

**NOTE:** Changes performed on the default IP Camera settings are at the responsibility of the installer.

---

# Product Specification

<b>Model</b>	<b>RVCM32W0200A</b>	
<b>Camera</b>		
Image Sensor	1/3" 1.3Megapixel progressive scan CMOS	
Effective Pixels	1280(H) x960(V)	
Scanning System	Progressive	
Electronic Shutter Speed	Auto/Manual, 1/3(4)~1/100000s	
Min. Illumination	0. 1Lux/F2.0(Color), 0Lux/F2.0(IR on)	
S/N Ratio	More than 50dB	
Video Output	N/A	
<b>Camera Features</b>		
Max. IR LEDs Length	30m	
Day/Night	Auto(ICR)/Color/B/W	
Backlight Compensation	BLC / HLC / DWDR	
White Balance	Auto/Manual	
Gain Control	Auto/Manual	
Noise Reduction	3D	
Privacy Masking	Up to 4 areas	
<b>Lens</b>		
Focal Length	3.6mm	
Max Aperture	F2.0(F2.0)	
Focus Control	Manual	
Angle of View	H: 72°(92°)	
Lens Type	Fixed lens	
Mount Type	Board-in Type	
<b>Video</b>		
Compression	H.264/H.264H/H.264B/MJPEG	
Resolution	1.3MP(1280×960)/720P(1280×720)/VGA(640×480)/QVGA(320×240)	
Frame Rate	Main Stream	1.3MP/720P(1 ~ 25/30fps)
	Sub Stream	VGA/QVGA(1 ~ 25/30fps)
Bit Rate	H.264: 32kbps~8192kbps	
Corridor Mode	Support	
<b>Audio</b>		
Compression	N/A	
Interface	N/A	

<b>Network</b>	
Ethernet	RJ-45 (10/100Base-T)
Wi-Fi	Wi-Fi(IEEE802.11b/g/n) 50m(open field)
Protocol	P2P, IPv4/IPv6, HTTP, HTTPS, TCP/IP, UDP, UPnP, ICMP, IGMP, RTSP, RTP, SMTP, NTP, DHCP, DNS, PPPOE, DDNS, FTP, IP Filter, QoS
Compatibility	ONVIF, CGI
Max. User Access	20 users
Smart Phone	iPhone, iPad, Android
<b>Auxiliary Interface</b>	
Memory Slot	Micro SD card, up to 128GB
RS485	N/A
Alarm	N/A
PIR Sensor Range	N/A
<b>General</b>	
Power Supply	DC12V
Power Consumption	<4.6W(IR on)
Frequency and Power	2412 – 2462 MHz, 0.0215 W 2422 – 2452 MHz, 0.0095 W
Working Environment	-30°C~+50°C, Less than 95% RH
Ingress Protection	IP67
Vandal Resistance	IK10
Dimensions	Φ110mm×81mm
Weight	0.55kg with package

## NOTES

## NOTES

# VUpoint

Caméra IP P2P Dôme Anti-Vandale



Modèle : RVCM32W

FR



<http://VUpoint-P2P.riscogroup.com/How-to-Install/>

**Guide d'installation**

## Consignes de sécurité

Ces instructions sont destinées à faire en sorte que l'utilisateur puisse utiliser le produit correctement pour éviter tout danger ou toute perte matérielle.

### MISES EN GARDE :

- Toute installation ou utilisation de ce produit sans respecter l'usage prévu tel que défini par le fournisseur et comme décrit dans les matériels pédagogiques peut entraîner des dommages, des blessures ou la mort.
- Tenez ce produit hors de portée des enfants et des personnes auxquelles il n'est pas destiné.
- L'installation et l'utilisation doivent être conformes aux codes de sécurité électrique locaux. L'alimentation doit être conforme aux dispositions de la SELV (Safety Extra Low Voltage) ; la source d'alimentation limitée doit être de 12 V CC conformément à la norme IEC60950-1.
- Si ce produit est raccordé de façon permanente à une source d'alimentation électrique, un dispositif de déconnexion facilement accessible, tel qu'un disjoncteur, doit être mis en place. Veillez à ne pas connecter simultanément les deux sources d'alimentation à l'appareil, car cela risque de l'endommager.
- Ne tentez jamais de réparer vous-même cet appareil, car cela risque de provoquer des dommages matériels, des blessures, voire la mort. Veillez à toujours contacter votre installateur/fournisseur pour toute maintenance.

### AVERTISSEMENTS :

- Assurez-vous que la tension d'alimentation est correcte avant d'utiliser la caméra.
- Veillez à ne pas laisser tomber la caméra ou à la soumettre à des chocs physiques.
- Ne touchez pas les modules capteurs avec les doigts. Si un nettoyage est nécessaire, utilisez un chiffon propre avec un peu d'éthanol et essuyez délicatement.
- N'exposez pas l'objectif de la caméra à une source lumineuse puissante, notamment à la lumière du soleil ou à une lampe à incandescence. Ces sources lumineuses risquent de provoquer des dommages matériels irréversibles.
- Un faisceau laser peut brûler le capteur ; par conséquent, lors de l'utilisation d'un appareil laser, vérifiez que la surface du capteur n'est pas exposée au faisceau laser.
- N'exposez pas la caméra à des températures extrêmes froides ou chaudes (la température de fonctionnement doit être comprise entre -10 °C et +50 °C).
- Pour éviter l'accumulation de chaleur et assurer un environnement d'utilisation correct, une bonne ventilation est nécessaire.
- Lors du transport, la caméra doit être placée dans son emballage d'origine.

**NOTE** : nous déclinons toute responsabilité en cas d'incendie ou de choc électrique dû à une manipulation et/ou une installation incorrectes. Nous ne pouvons être tenus pour responsables en cas de problèmes causés par une modification ou une tentative de réparation non autorisées.

## Introduction

RISCO Group présente VUpoint, une solution de vérification vidéo en direct révolutionnaire qui intègre de façon transparente les caméras IP au sein de nos systèmes de sécurité professionnels Géré par RISCO Cloud, VUPoint offre un niveau de sécurité sans précédent en offrant la surveillance vidéo en direct aux stations de télésurveillance et aux utilisateurs commerciaux/résidentiels. La Caméra IP Dôme Intérieure et Extérieure de RISCO est une partie importante de cette solution et est facilement contrôlé par les applications Smartphone et Web intuitives de RISCO.

## Caractéristiques

- Installation Plug & Play
- 1,3 Mégapixel
- Couleur HD
- Modes Jour/Nuit
- LED IR d'une portée de 30 m

## Composants et accessoires

Caméra IP RISCO et support de montage :

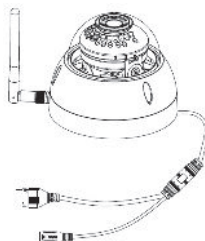

Guide d'installation :



## Composants et dimensions de la caméra IP

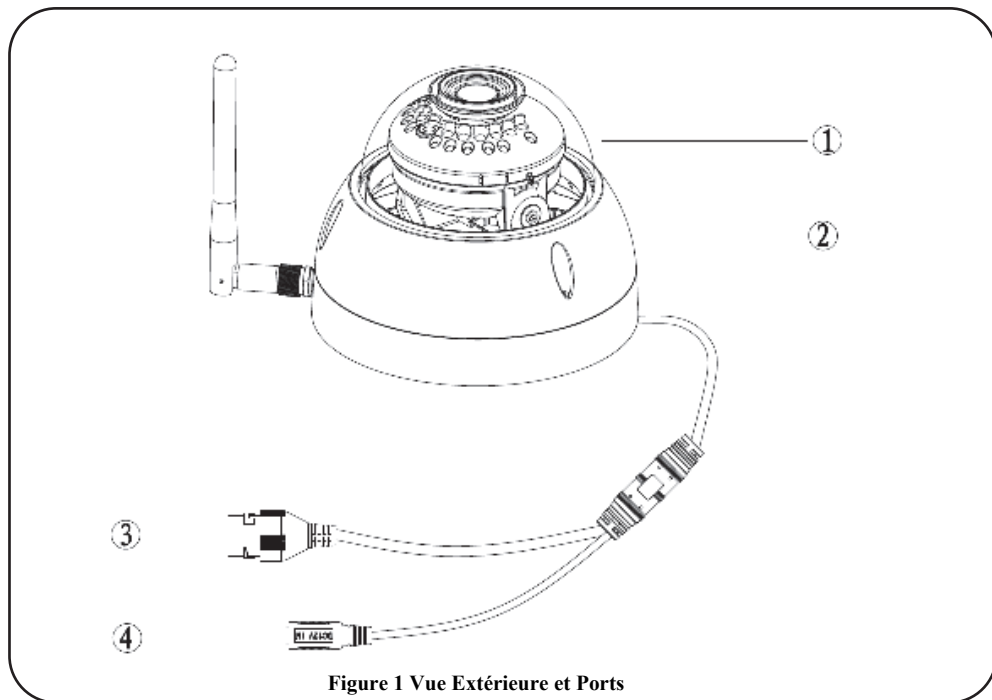

Figure 1 Vue Extérieure et Ports

Libellé	Nom
1	Cache du dôme
2	Boîtier du dôme
3	Port réseau
4	Port d'alimentation

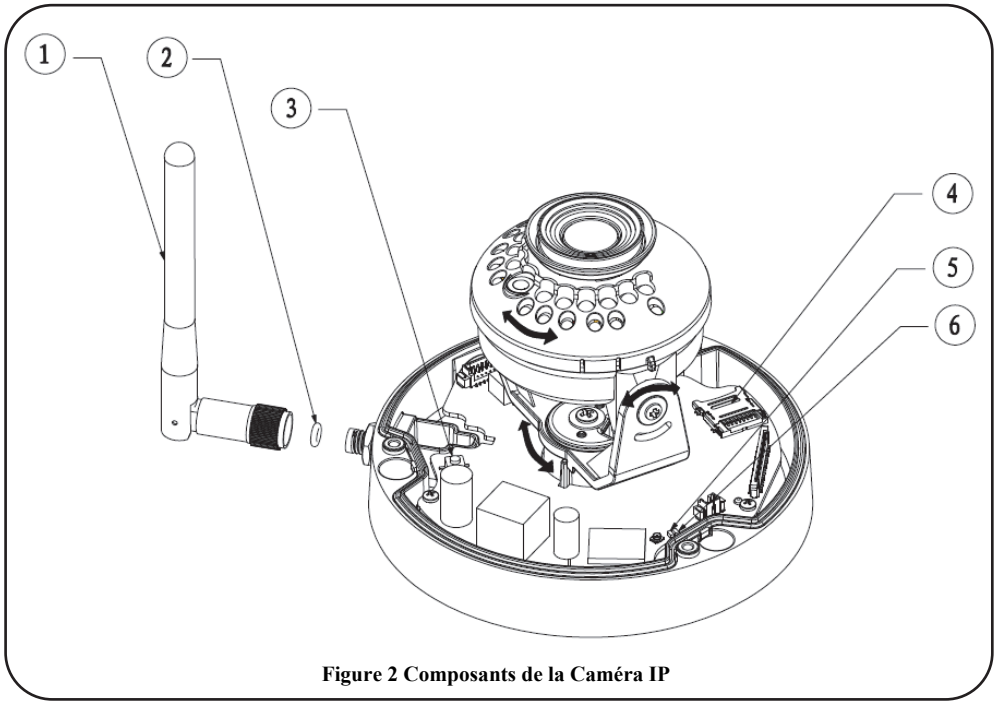

Figure 2 Composants de la Caméra IP

Libellé	Nom
1	Antenne Wi-Fi
2	Anneau d'étanchéité
3	Bouton de Réinitialisation/WPS (Wi-Fi Protected Setup)
4	Logement pour carte Micro SD
5	Voyant d'indication 1
6	Voyant d'indication 2

**Note :**

- Pour la réinitialisation (utilisée pour rétablir la caméra à ses paramètres usine par défaut), appuyez pendant 15 secondes sur le bouton, jusqu'à ce que la lumière s'éteigne.
- Pour le WPS (Wi-Fi Protected Setup), faites un appui rapide sur le bouton.

Indication	État
Voyant rouge allumé normalement	Démarrage en cours
Voyant vert clignotant lentement	La caméra IP n'est pas connectée à RISCO Cloud. Vérifiez la connexion Internet et essayez de reconnecter la caméra IP en la redémarrant.
Voyant vert clignotant rapidement	Configuration Wi-Fi intelligente en cours, à savoir fonction WPS (Wi-Fi Protected Setup), trame de gestion, etc.
Voyant vert allumé normalement	La caméra IP est bien connectée au RISCO Cloud.
Voyants rouge et vert clignotant en alternance	Mise à jour de l'appareil
Voyant rouge clignotant lentement	Échec de la connexion réseau ou déconnexion après une connexion réseau réussie
Voyant rouge clignotant rapidement	Dysfonctionnement de l'appareil, échec du démarrage, alarme ou dysfonctionnement de la carte SD

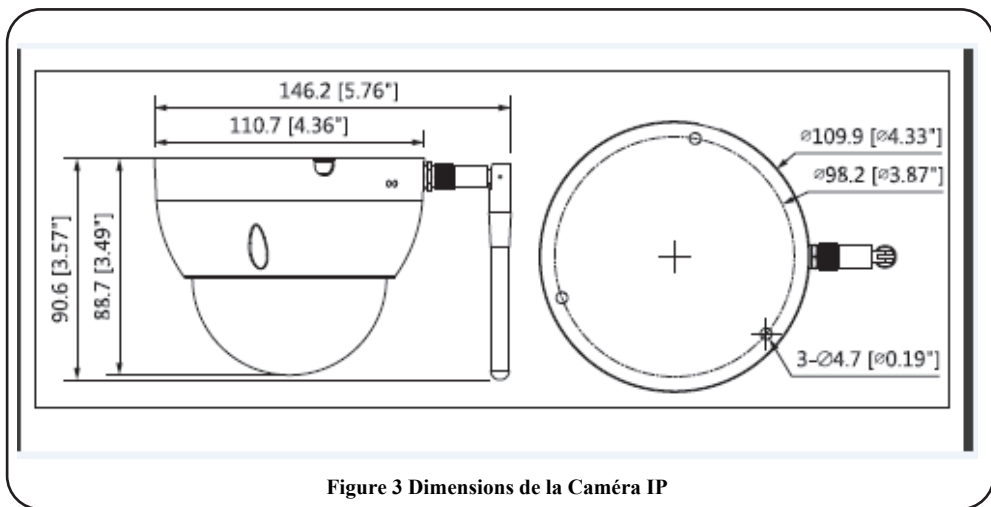

Figure 3 Dimensions de la Caméra IP

## Installation de la caméra IP

Après avoir lu les instructions d'installation et avant d'installer votre caméra IP, préparez un plan de montage de la caméra IP correspondant au site à protéger. Il est crucial de déterminer l'emplacement correct de votre caméra IP afin d'assurer des performances de surveillance et de sécurité optimales. Déterminez tout d'abord les zones devant être protégées, puis élaborez un plan afin d'identifier les meilleurs emplacements d'installation de votre caméra IP.

**IMPORTANT !** - Notez l'adresse MAC située sur l'emballage ou sur la partie arrière de la caméra IP avant l'installation. Vous pourriez en avoir besoin lors de la connexion au réseau.

Adresse MAC

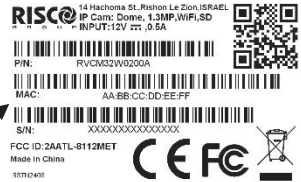

## Montage de la caméra IP

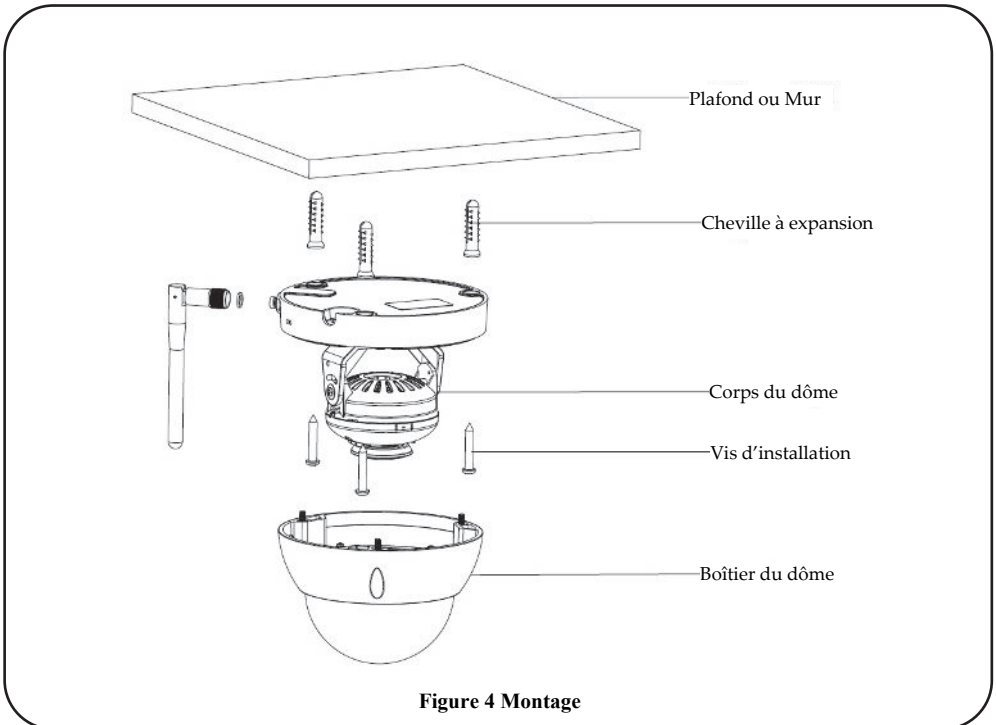

**IMPORTANT** - Assurez-vous que la surface de montage peut supporter au moins trois fois le poids de la caméra et de son support.

Étape	Description
1	Utilisez la clé hexagonale fournie pour desserrer les trois vis internes et ouvrir le boîtier du dôme.
2	Placez le gabarit de positionnement d'installation sur la surface d'installation tel que le plafond ou le mur.
3	Faites des trous dans la surface d'installation en suivant les repères du gabarit de positionnement d'installation.
4	Insérez les chevilles (fournies dans le sachet d'accessoires) dans les trous que vous venez de percer.
5	Placez la base de la caméra IP sur les trous.
6	Utilisez les vis (fournies dans le sachet d'accessoires) pour fixer la caméra IP fermement.
	<ul style="list-style-type: none"><li>• Si vous faites passer le câble par le haut de la surface d'installation, percez un trou de sortie sur cette dernière en fonction du gabarit de positionnement d'installation.</li><li>• Si vous faites passer le câble par le côté de la voie de câbles, insérez-le dans l'orifice en forme de U sur le support du dôme. Retirez le câble du côté de l'orifice de sortie situé sur le support.</li></ul>
7	Placez le support d'installation à la position adéquate, puis faites passer le câble par l'orifice de sortie situé sur la surface d'installation.
8	Alignez le repère TOP du support d'installation avec celui du gabarit d'installation.
9	Alignez les trois trous de vis sur le support avec les trois orifices pour chevilles en plastique sur le gabarit d'installation.
10	Utilisez les vis (fournies dans le sachet d'accessoires) pour fixer la caméra IP fermement.
11	Fixez le corps du dôme à la surface d'installation.
12	Tenez la base du support de rotation des deux côtés, faites-le pivoter horizontalement le long de l'axe et réglez l'objectif dans le sens horizontal à la position désignée.

Étape	Description
13	<p>Tenez le cache du voyant à LED et faites-le pivoter verticalement tout en ajustant l'objectif dans le sens vertical vers la position désignée.</p> <p>Si vous avez du mal à effectuer cette opération, desserrez tout d'abord les vis fixes sur les deux côtés du support (sans les retirer), puis réglez l'objectif et serrez de nouveau les vis.</p>
14	<p>Tenez le cache du voyant à LED tout en faisant pivoter le long de l'axe et réglez l'image de l'objectif sur la position de surveillance correcte.</p> <p><b>Plage de l'objectif :</b></p> <ul style="list-style-type: none"> <li>• verticale (0 °~+64 °)</li> <li>• horizontale (0 °~+355 °)</li> <li>• sens de rotation de l'image (0 °~+355 °)</li> </ul> <p><b>REMARQUE :</b> une fois que la rotation verticale atteint 64 °, observez attentivement le sens de rotation de l'image afin d'éviter que le couvercle extérieur ne bloque la lumière infrarouge, car cela risque d'avoir un impact négatif sur la fonction infrarouge.</p>

## Mise sous tension de la caméra IP

1. Connectez l'alimentation au port d'alimentation de la caméra IP.
2. Connectez l'alimentation à une prise électrique. Lors du démarrage de la caméra IP, le voyant VERT clignote.

## Connexion de la caméra IP au réseau

La caméra IP supporte plusieurs options de connexion au réseau, notamment au réseau local LAN et au réseau sans fil.

### Connexion à un réseau local

La connexion de la caméra IP à un réseau local (LAN, Local Area Network) facilite la connexion et les réglages avec les points d'accès compatibles, par exemple une passerelle ou un routeur.

1. Connectez le câble réseau entrant au port réseau sur la caméra IP.
2. Le voyant VERT d'indication réseau clignote pour indiquer que votre caméra est maintenant connectée au réseau. Continuez en suivant les instructions de la section Définition des paramètres de la caméra IP.

## Connexion à un réseau sans fil via WPS

Pour connecter la caméra IP à un réseau sans fil via WPS (Wi-Fi Protected Setup), le routeur doit prendre en charge la fonctionnalité WPS.

---

**REMARQUE** : le logiciel de gestion de certains routeurs est muni d'un bouton virtuel. Reportez-vous à la documentation du routeur pour plus de détails sur l'utilisation des fonctions WPS.

---

1. Une fois le câble d'alimentation connecté, attendez que le voyant réseau VERT clignote lentement.
2. Appuyez rapidement sur le bouton WPS de la caméra IP tout en maintenant enfoncé le bouton WPS du routeur pendant 2 secondes. Lorsque le voyant réseau VERT cesse de clignoter, votre caméra IP est connectée au réseau. Continuez en suivant les instructions de la section Définition des paramètres de la caméra IP.

## Connexion à un réseau sans fil à l'aide de RISCO Cloud

Pour connecter la caméra IP à un réseau sans fil via le RISCO Cloud (Serveur d'Application RISCO), vous devez tout d'abord raccorder la caméra IP au routeur via le réseau local, puis définir les paramètres de la caméra IP et établir une connexion sans fil via l'application Installateur RISCO Cloud. Une fois la connexion sans fil établie, vous pouvez déconnecter la caméra IP du routeur et l'installer/la monter.

1. Connectez le câble réseau entrant au port réseau sur la caméra IP.
2. Le voyant VERT d'indication réseau clignote pour indiquer que votre caméra est maintenant connectée au réseau. Continuez en suivant les instructions de la section Définition des paramètres de la caméra IP.

---

**REMARQUE** : avant de procéder à la déconnexion, vous devez configurer le réseau sans fil via RISCO Cloud.

---

3. Une fois la connexion sans fil établie, vous pouvez déconnecter la caméra IP du routeur et l'installer/la monter à l'emplacement de votre choix de la zone surveillée.

# Caméras IP et Application Installateur RISCO Cloud

L'application Installateur RISCO Cloud fournit une interface pour contrôler votre centrale à partir d'un PC local ou à distance via le Web. Cela vous permet d'ajouter des caméras IP et de définir la caméra et les paramètres des événements d'alarme de déclenchement.

**IMPORTANT** - Une centrale doit d'abord être définie dans RISCO Cloud avant d'ajouter des caméras IP et de définir leurs paramètres (reportez-vous au manuel de l'application Installateur RISCO Cloud).

## Définition des paramètres de la caméra IP

Après avoir connecté la caméra IP au réseau (reportez-vous à la rubrique Connexion de la caméra IP au réseau), vous pouvez définir ses paramètres.

### Pour définir les paramètres de la caméra IP :

1. Connectez-vous à l'application Installateur en utilisant l'adresse de la page Web indiquée par votre fournisseur de services, puis saisissez votre nom d'utilisateur et votre mot de passe.

**REMARQUE** : il est recommandé d'utiliser Google Chrome ou Mozilla Firefox pour se connecter à l'application Installateur.

2. Sélectionnez le lien Liste de centrales. La page Liste des centrales s'affiche.

CP Login ID	Web Login ID	First Name	Last Name	Cell Phone	Provider (1st)	Account	Last Connected Time	Online?
TCONNECT203							7/17/2012 9:39:48 AM	No
2240000123							4/19/2012 5:34:47 PM	No
22400048768								Never
22400036472							5/14/2012 3:26:34 PM	No
2240000014							4/25/2012 9:00:11 AM	No
22400065764							5/21/2012 3:25:56 PM	No
2240000010							4/30/2012 1:11:16 PM	No
22400066013							5/2/2012 4:55:14 PM	No
2240000012							9/27/2012 1:01:38 PM	No
22400065725							9/19/2012 12:27:16 PM	No

Figure 5 Page Liste des centrales

3. Dans la page Liste des centrales, sélectionnez la centrale que vous souhaitez consulter. La page de modification des centrales s'affiche.

Figure 6 Page Mise à jour des centrales

4. Cliquez sur le lien Caméras IP dans la colonne de gauche ; la page des caméras IP s'affiche.

Figure 7 Page des caméras IP

5. Cliquez sur Ajout Caméra ; la boîte de dialogue correspondante s'affiche.
6. Sélectionnez le type de caméra IP RISCO P2P.

Figure 8 Ajout Caméra

7. Renseignez les champs suivants dans la boîte de dialogue Ajout Caméra.

Champ	Description
<b>Nom</b>	Saisissez le nom de la caméra.
<b>Partitions</b>	Sélectionnez la ou les partitions dans la liste des partitions définies.
<b>Type</b>	Sélectionnez le type de caméra RISCO P2P (pour les paramètres de type ONVIF ou Caméra générique, reportez-vous au Guide de l'application Installateur RISCO Cloud)
<b>Adresse MAC</b>	Saisissez l'adresse MAC dans ce champ. L'adresse MAC (Media Access Control) est l'identifiant unique affecté à la caméra IP pour communiquer sur le réseau physique.

**REMARQUE** : l'adresse MAC est sensible à la casse et doit être saisie exactement comme elle est indiquée sur le carton d'emballage ou sur l'arrière de la caméra IP ; par exemple, AA:BB:CC:DD:EE:FF.

8. Cliquez sur Ajouter ; le message suivant s'affiche.

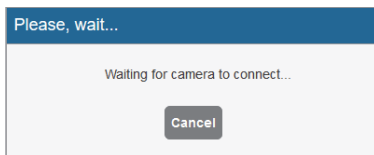

Figure 9 Message « La caméra est en cours de connexion... »

Si le message « Votre caméra a été identifiée avec succès. Voulez-vous la connecter à votre réseau Wi-Fi ? » s'affiche, passez directement à l'étape 9.

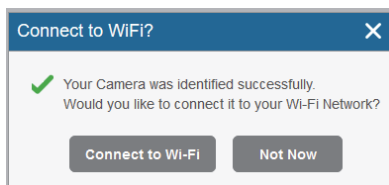

Figure 10 Message d'identification réussie

9. Sélectionnez l'une des options suivantes :

**Connecter au Wi-Fi** : cette option permet d'établir une connexion au réseau sans fil (passez à l'étape 10 pour connecter la caméra IP au réseau Wi-Fi).

**Pas maintenant** : cette option permet de maintenir la connexion de la caméra IP à l'aide d'un réseau LAN (ignorez les étapes de connexion au réseau sans fil 10, 11 et 12, et connectez la caméra IP au réseau LAN).

10. Si vous avez sélectionné l'option « Connecter au Wi-Fi », une liste des réseaux sans fil disponibles s'affiche.



Figure 11 Liste des réseaux sans fil disponibles

11. Sélectionnez un réseau sans fil dans la liste et cliquez sur Connecter.

**NOTE** - si votre réseau est protégé par un mot de passe, saisissez le mot de passe dans l'écran correspondant.

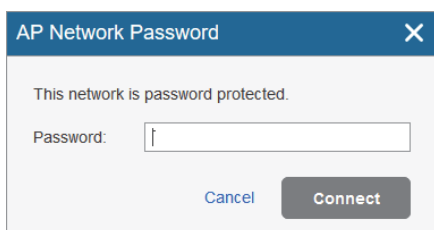

Figure 12 Mot de passe du réseau du point d'accès

12. Cliquez sur Connexion pour établir la connexion sans fil (reportez-vous à la section Connexion à un réseau sans fil à l'aide de RISCO cloud) ; le message suivant s'affiche.

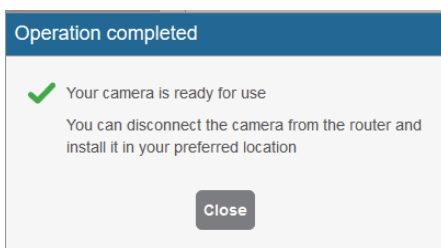

Figure 13 Opération terminée

13. Lorsque le message « La caméra est prête à être utilisée » s'affiche, cliquez sur Fermer. La caméra IP définie s'affiche sur la page Caméras IP.

**REMARQUE** : une fois la connexion sans fil établie, n'oubliez pas de déconnecter le câble Ethernet de la caméra IP du routeur.

## IP Cameras

Label	Partition	Type	MAC Address	Wi-Fi	Actions
Main Entrance cam	Lobby Floor	RISCO	00-10-5A-44-12-B5	Connected	
Front yard cam	Lobby Floor, Storage Rooms	RISCO	00-10-2B-36-11-18	Connect	
Lobby cam	Lobby Floor	Generic	11-10-5A-44-12-B5	Connect	
Living Room	Storage Rooms	ONVIF	07-10-5A-4A-28-B6	Connected	
Second Floor north cam	Storage Rooms	ONVIF	00-10-5A-44-12-B5	Connected	
Basement	Sun Microsystems	RISCO	03-10-5A-44-12-B5	Connected	

Figure 14 Liste des caméras IP

**REMARQUE** : vous avez également la possibilité de modifier ou de supprimer la caméra IP sélectionnée.

Cliquez sur le bouton d'action FW ci-dessous pour vérifier si le firmware est à jour.

## IP Cameras

Label	Partition	Type	MAC/IP Address	Wi-Fi	Actions
Cube - Office	Partition 1	RISCO P2P Camera	3C:EF:8C:DF:6C:59	Risco-Guest	

Figure 15 Mise à jour du firmware

La version la plus récente du firmware apparaît dans l'écran qui s'affiche, le cas échéant.

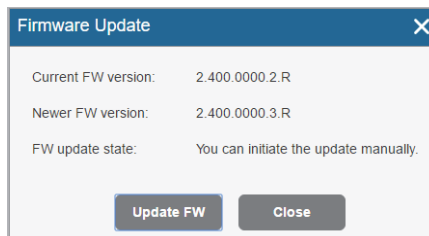

Figure 16 Version la plus récente du firmware

## Définition des paramètres de déclenchement de la caméra

Tout événement dans la liste suivante peut être défini pour déclencher une alarme.

Événements de partition			
Alarme incendie	Alarme panique	Alarme médicale	Alarme
Armement complet	Armement partiel	Désarmement	Contrainte
Autoprotection	Alarme 24 h	Alarme Inondation	Alarme gaz
Alarme environ.	Alarme inactivité	Alarme sortie	Température basse
Événements de détecteur			
Alarme	Zone exclue	Zone incluse	Autoprotection zone

### Pour définir les paramètres de déclenchement de la caméra :

1. Sur la page de configuration des Caméras, cliquez sur l'onglet Déclencheurs ; la liste des déclencheurs de la caméra s'affiche.

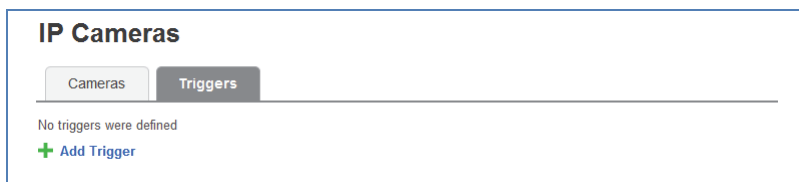

Figure 17 Liste des déclencheurs de la caméra

2. Cliquez sur Ajout de déclencheur ; la boîte de dialogue d'ajout de nouveau déclencheur s'affiche.

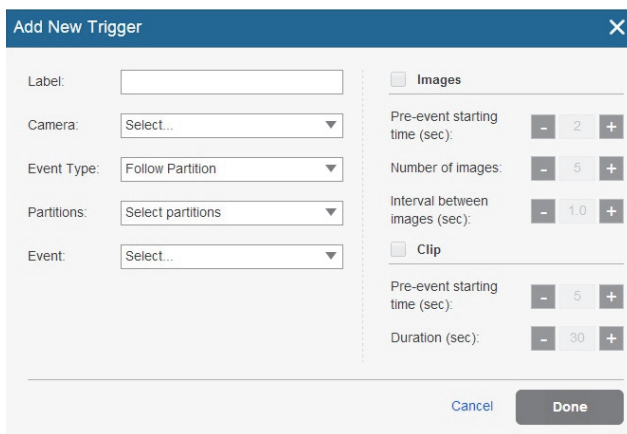

Figure 18 Ajout de nouveau déclencheur

3. Renseignez les champs suivants dans la boîte de dialogue Ajout de nouveau déclencheur.

Champ	Description	Type d'événement
Nom	Saisissez le nom du déclencheur de la caméra.	Événements de partition et de détecteur
Caméra	Sélectionnez une caméra dans la liste.	Événements de partition et de détecteur
Type d'événement	Sélectionnez un type d'événement dans la liste.	Événements de partition et de détecteur
Événement	Sélectionnez l'événement dans la liste (ex., alarme, contrainte, etc.)	Événements de partition et de détecteur

D'autres champs sont disponibles dans la boîte de dialogue Ajout de déclencheur selon le type d'événement sélectionné (reportez-vous aux exemples ci-dessous pour les types d'événements de partition et de détecteur).

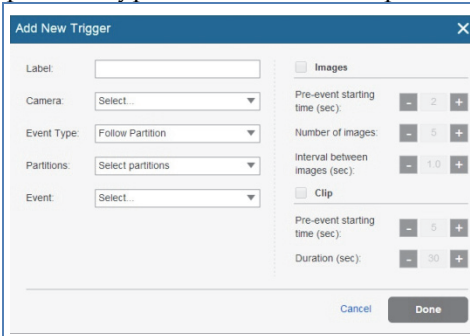

Figure 19 Ajout d'un événement de partition

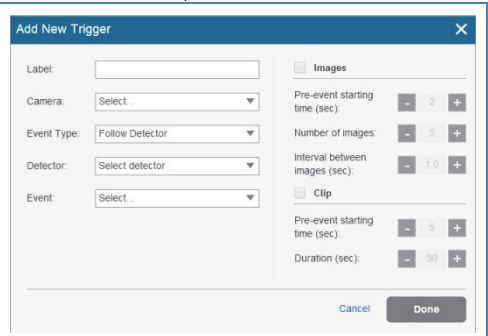

Figure 20 Ajout d'un événement de détecteur

4. Renseignez les champs suivants dans la boîte de dialogue d'ajout de déclencheur selon le type d'événement que vous avez sélectionné.

Champ	Description	Type d'événement
Partition(s)	Sélectionnez la ou les partitions dans la liste. <b>REMARQUE</b> : seules les partitions associées à la caméra s'affichent.	Événements de partition uniquement
Détecteurs	Sélectionnez le détecteur dans la liste.	Événements de détecteur uniquement

5. Sélectionnez les définitions d'image et de clip :

Champ	Description
<b>Images (fixes)</b>	<b>Durée de pré-alarme (sec)</b> : durée avant le déclenchement de l'événement en cours pour démarrer l'affichage des images. <b>Nombre d'images</b> : nombre d'images à afficher. <b>Intervalle entre images (sec)</b> : durée requise entre chaque image.
<b>Clip (vidéo)</b>	<b>Durée de pré-alarme (sec)</b> : durée avant le déclenchement de l'événement en cours pour démarrer l'enregistrement du clip. <b>Durée (sec)</b> : durée totale de la séquence vidéo <b>NOTE</b> : ces champs sont actuellement verrouillés et il est impossible de modifier les paramètres par défaut.

**NOTE:** Afin de pouvoir enregistrer des clips vidéos, vous devez insérer une carte Micro SD puis désalimenter et ré-alimenter la caméra.

6. Lorsque vous avez terminé, cliquez sur OK. Le déclencheur de caméra défini apparaît désormais dans la liste des déclencheurs de caméra.

## IP Cameras

Cameras

Triggers

+ Add Trigger

Label	Event	Camera	Camera Operations	Actions
Lobby floor alarm	Partition - Lobby Floor Alarm Follow	Street cam North	3 images, 10 seconds clip	
Storage Tamper	Partition - Storage Rooms Tamper Follow	Street cam South	1 image	
Lobby Arming	Detector - Lobby South-East Arm Follow	Lobby main cam	5 images, 20 seconds clip	

Duplicate

**Figure 21** Liste des déclencheurs de la caméra

**NOTE** - vous avez également la possibilité de modifier , de dupliquer ou de supprimer le déclencheur sélectionné.

**IMPORTANT** - il est impossible de définir de façon identique deux déclencheurs de caméra. Si un déclencheur est dupliqué, il est nécessaire de modifier la définition d'événement, la définition de caméra, ou les deux.

## Paramètres avancés

Pour des raisons de sécurité, nous avons pris des mesures pour minimiser les risques de piratage en limitant l'accès à la caméra IP. Néanmoins, il est dans certains cas nécessaire de modifier les paramètres par défaut de la caméra IP en fonction des conditions de ce champ. Cette modification doit être confiée à des utilisateurs expérimentés autorisés à accéder aux paramètres de la caméra IP.

### Pour accéder aux paramètres de la caméra IP

1. Cliquez sur le bouton « ... » ci-dessous pour activer l'option UI/CGI.

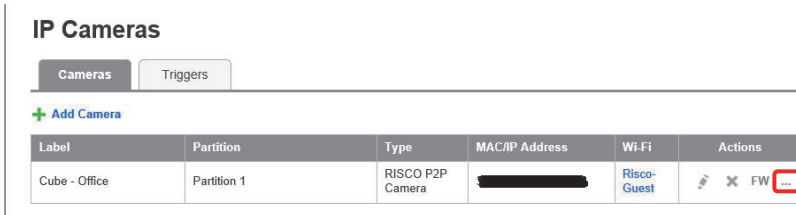

Figure 22 Paramètres de la caméra IP

L'écran suivant s'affiche.



Figure 23 Cochez la case UI/CGI

2. Cochez la case UI/CGI.
3. Cliquez sur Enregistrer.

L'installateur peut désormais accéder à l'interface Web de la caméra IP pour une durée d'une heure. Ouvrez le navigateur Internet, puis saisissez l'adresse IP de la caméra. Par défaut, le nom d'utilisateur et le mot de passe de la caméra IP sont, respectivement, « admin » et « \_AdmiN\_ + l'adresse MAC de la caméra IP » (par exemple, \_AdmiN\_AABBCCDDEEFF).

---

**REMARQUE** : au bout d'une heure, l'accès à la caméra est désactivé.

---

## Raccordement à un enregistreur vidéo réseau local (NVR)

L'installateur peut connecter la caméra IP à un NVR local. Il doit pour cela déterminer l'adresse IP de la caméra IP, et configurer la caméra en tant que caméra ONVIF dans le NVR. L'installateur doit par ailleurs saisir les informations d'identification de la caméra IP. Par défaut, le nom d'utilisateur et le mot de passe de la caméra IP sont, respectivement, « admin » et « \_AdmiN\_ + l'adresse MAC de la caméra IP » (par exemple, \_AdmiN\_AABBCCDDEEFF). Les mêmes informations d'identification sont utilisées pour la caméra ONVIF. Désormais, l'installateur peut également accéder au flux en direct de la caméra IP.

---

**REMARQUE** : les modifications apportées aux paramètres par défaut de la caméra IP relèvent de la responsabilité de l'installateur.

---

# Spécifications du produit

<b>Modèle</b>	<b>RVCM32W0200A</b>	
<b>Caméra</b>		
Capteur d'image	CMOS 1/3" à balayage progressif de 1,3 Mégapixel	
Pixels effectifs	1 280 (H) x 960 (V)	
Système de balayage	Progressif	
Vitesse d'obturation électronique	Auto/Manuelle, 1/3(4)~1/100 000 s	
Illumination min.	0. 1 Lux/F2.0 (couleur), 0 Lux/F2.0 (IR activé)	
Rapport signal sur bruit	Supérieur à 50 dB	
Sortie vidéo	N/A	
<b>Caractéristiques de la caméra</b>		
Portée max. des LEDs IR	30 m	
Modes Jour/Nuit	Auto (ICR)/Couleur/Noir et blanc	
Compensation de rétroéclairage	BLC/HLC/DWDR	
Balance des blancs	Auto/Manuelle	
Contrôle du gain	Auto/Manuel	
Réduction du bruit	3D	
Masque de confidentialité	Jusqu'à 4 zones	
<b>Objectif</b>		
Focale	3,6 mm	
Ouverture max.	F2.0 (F2.0)	
Contrôle de mise au point	Manuel	
Angle de vue	H : 72 °(92 °)	
Type d'objectif	Objectif fixe	
Type de monture	Intégré	
<b>Vidéo</b>		
Compression	H.264/H.264H/H.264B/MJPEG	
Résolution	1,3 mégapixel (1 280×960)/720P (1 280×720)/ VGA (640×480)/QVGA (320×240)	
Flux Vidéo	Flux principal	1,3 mégapixel/720P (1~25/30 ips)
	Flux secondaire	VGA/QVGA (1 ~ 25/30 ips)
Débit vidéo	H.264 : 32 Kb/s~8 192 Kb/s	
Mode Corridor	Pris en charge	
<b>Audio</b>		
Compression	N/A	
Interface	N/A	

<b>Réseau</b>	
Ethernet	RJ-45 (10/100Base-T)
Wi-Fi	Wi-Fi (IEEE802.11b/g/n) 50 m (champ libre)
Protocole	P2P, IPv4/IPv6, HTTP, HTTPS, TCP/IP, UDP, UPnP, ICMP, IGMP, RTSP, RTP, SMTP, NTP, DHCP, DNS, PPPOE, DDNS, FTP, IP Filter, QoS
Compatibilité	ONVIF, CGI
Accès utilisateur max.	20 utilisateurs
Smartphone	iPhone, iPad, Android
<b>Interface auxiliaire</b>	
Logement mémoire	Carte Micro SD, jusqu'à 128 Go
RS485	N/A
Alarme	N/A
Plage du capteur IRP	N/A
<b>Généralités</b>	
Alimentation	12 V CC
Consommation	< 4,6 W (IR activé)
Fréquence et Puissance	2412 – 2462 MHz, 0.0215 W 2422 – 2452 MHz, 0.0095 W
Environnement d'utilisation	-30 °C~+50 °C, moins de 95 % HR
Indice de protection	IP67
Résistance au vandalisme	IK10
Dimensions	Φ110 mm × 81 mm
Poids	0,55 kg, emballage compris

## NOTES

# NOTES

# VUpoint Telecamera Dome P2P Anti-Vandalismo



**Modello: RVCM32W**

IT



<http://VUpoint-P2P.riscogroup.com/How-to-Install/>

## Manuale di Installazione

## Precauzioni sulla sicurezza

Queste istruzioni hanno lo scopo di garantire che l'utente utilizzi il prodotto in modo corretto per evitare pericoli o danni a terzi.

### AVVERTENZE:

- L'installazione o l'utilizzo di questo prodotto non in conformità con la destinazione d'uso, come definito dal fornitore e come descritto nel seguente manuale, può provocare danni, lesioni o morte.
- Assicurarci che questo prodotto non sia accessibile a bambini o a persone a cui il sistema non è destinato.
- L'installazione e il collegamento devono essere conformi alle norme di sicurezza del proprio paese ed effettuate da persone esperte. L'alimentatore utilizzato per il suddetto prodotto deve avere tensione di uscita 12 Vdc e deve essere conforme al requisito SELV (Safety Extra Low Voltage) (IEC60950-1).
- Se il dispositivo è collegato in modo permanente ad una fonte di alimentazione elettrica, allora la connessione deve includere un dispositivo di disconnessione facilmente accessibile, ad esempio un magnetotermico.
- Non tentare mai di riparare il dispositivo da soli in quanto ciò potrebbe causare danni, lesioni o morte. Contattare sempre il vostro installatore/fornitore.

### PRECAUZIONI:

- Assicurarci che la tensione di alimentazione sia corretta prima di utilizzare la telecamera.
- Non far cadere la telecamera o sottoporla a urti.
- Non toccare il modulo sensore con le dita. Se è necessario pulire l'apparato, utilizzando un panno pulito e strofinando delicatamente.
- Non puntare l'obiettivo della telecamera direttamente verso fonti di luce come il sole o una lampada ad incandescenza. La luce forte può provocare danni irreparabili alla telecamera.
- Il sensore della telecamera può essere bruciato da un raggio laser. Quando viene utilizzata qualsiasi apparecchiatura laser assicurarsi che la superficie del sensore non sia esposta allo stesso.
- Non posizionare la telecamera in condizioni ambientali estreme (la temperatura di esercizio deve essere compresa tra  $-20^{\circ}\text{C}$  ~  $+60^{\circ}\text{C}$ ).
- Per evitare surriscaldamenti il luogo di installazione deve avere una ventilazione adeguata.
- Durante il trasporto, la telecamera deve essere contenuta nel suo imballo originale.

**NOTE:** RISCO non si assume la responsabilità per eventuali incendi o scosse elettriche causate da un uso improprio o da un'installazione non corretta dell'apparato. RISCO non è altresì responsabile per eventuali problemi causati da modifiche non autorizzate o tentativi di riparazione effettuate sul prodotto.

## Introduzione

RISCO Group presenta VuPoint, una soluzione rivoluzionaria di verifica video live che integra perfettamente le Telecamere IP nei sistemi di sicurezza professionali RISCO. Utilizzando il Cloud di RISCO, VuPoint fornisce un livello di sicurezza e di monitoraggio video in tempo reale per le Vigilanze e gli utenti finali senza precedenti. La telecamera IP Dome di RISCO, per uso interno ed esterno, è parte integrante di questa soluzione ed è facilmente controllabile attraverso applicazioni smartphone o attraverso intuitive pagine Web.

## Caratteristiche

- Installazione Plug & Play
- 1.3" Megapixel
- Colore HD
- Day/Night
- Illuminatore IR (Portata 30 metri)

## Componenti e accessori

Telecamera Dome RISCO e  
staffa di montaggio:

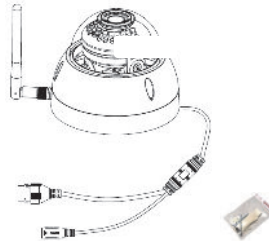

Manuale di Installazione:



## Telecamera IP - Componenti e Dimensioni



Figura 1 connessioni Telecamera IP

Etichetta	Descrizione
1	Guscio telecamera Dome
2	Corpo telecamera Dome
3	Presca di rete
4	Presca di alimentazione

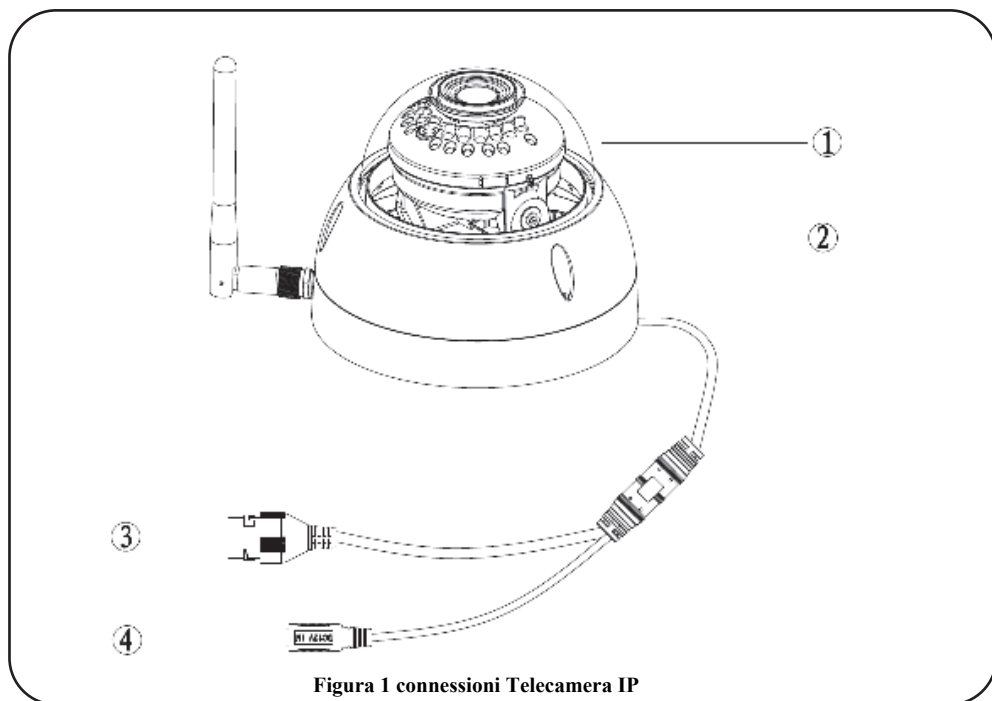
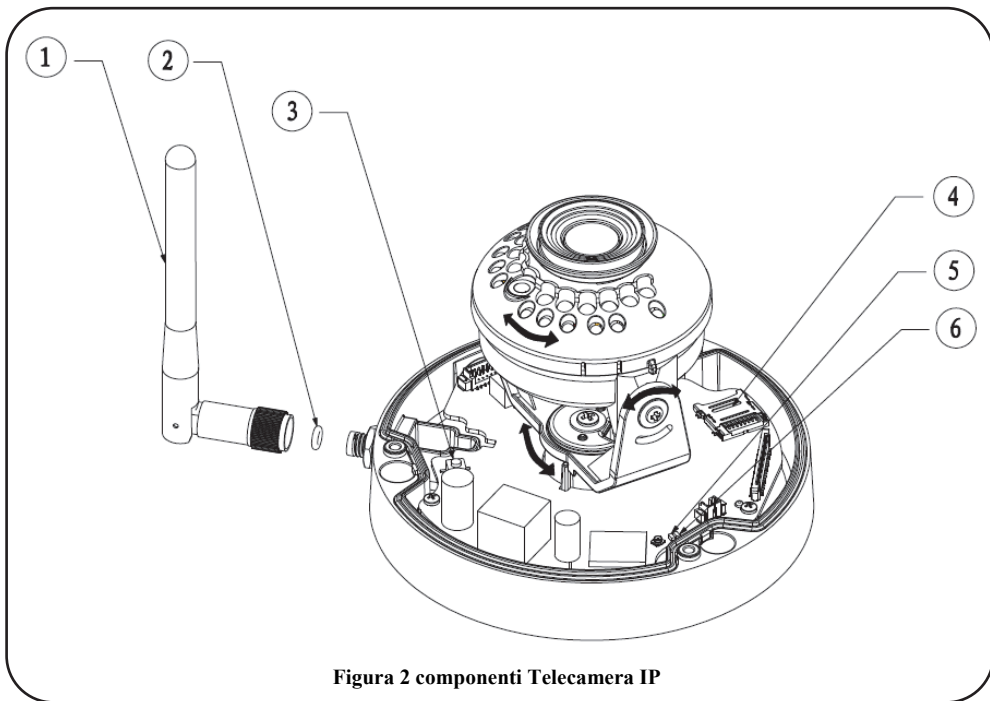

**Figura 2 componenti Telecamera IP**

<b>Etichetta</b>	<b>Descrizione</b>
1	Antenna Wireless
2	Anello a protezione da infiltrazioni di acqua
3	Pulsante Reset/ WPS (Wi-Fi Protected Setup)
4	Ingresso Micro SD card
5	LED 1
6	LED 2

## Scheda SD

Nelle telecamere Risco è possibile inserire una SD Card da un minimo di 8Gb ad un massimo di 128 Gb.

Nella SD oltre le videoclip generate attraverso i trigger impostati dal Cloud Risco è possibile videoregistrare in modalità continua.

La videoregistrazione, essendo una funzionalità impostabile sulla telecamera è indipendente dalle funzionalità del Cloud Risco.

E' possibile visualizzare questi filmati solamente collegandosi alla telecamera tramite accesso locale via WEB, andando nel menù Playback.

A seconda della SD utilizzata e della risoluzione impostata, si può registrare fino a 30 giorni continuativi.

---

### Nota:

- Per eseguire il reset (portare la telecamera alle sue impostazioni di fabbrica), premere il tasto reset per 15 secondi finchè i led si spengono
- Per attivare il WPS (Wi-Fi Protected Setup), premere normalmente il tasto.

Indicazione LED	Significato
Led rosso acceso	Telecamera alimentata
Led verde lampeggio lento	Telecamera IP non connessa al Cloud RISCO. Controllare la connettività e riavviare la telecamera.
Led verde lampeggio rapido	configurazione smart WiFi in corso (modalità WPS).
Led verde acceso	Connessione al Cloud RISCO avvenuta con successo.
lampeggio alternato led rosso e verde	Aggiornamento dispositivo
Led rosso lampeggio lento	Connessione di rete fallita o disconnessione.
Led rosso lampeggio rapido	Malfunzionamento dispositivo, avvio fallito; malfunzionamento scheda SD

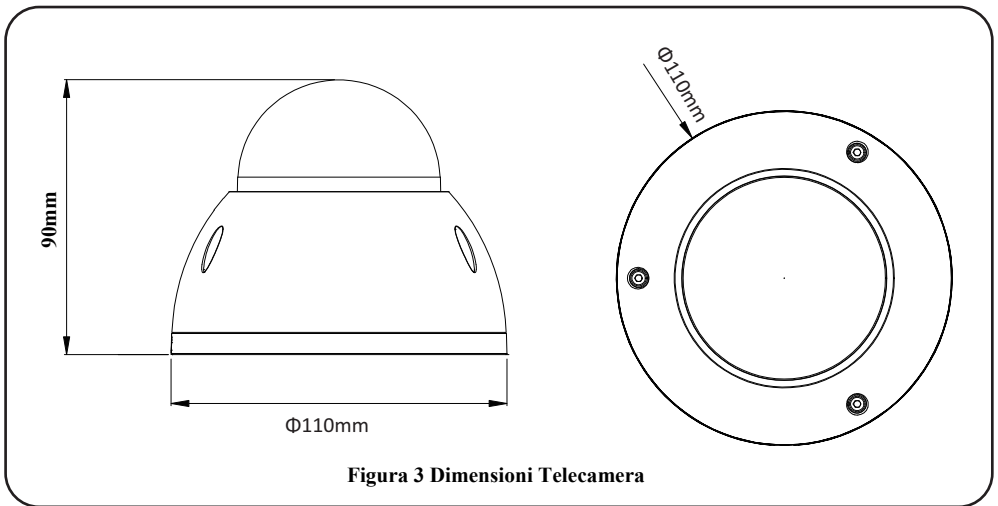

## Telecamera IP - Installazione

Dopo aver letto le istruzioni di installazione e prima di installare la telecamera IP, preparare un piano per il montaggio della stessa nel sito da proteggere.

Il corretto posizionamento della telecamera IP è fondamentale per ottenere prestazioni ottimali di sicurezza e sorveglianza. In primo luogo, determinare quali sono le aree da proteggere e poi scegliere il luogo ottimale dove installare la telecamera IP.

**IMPORTANTE!** – Prima della installazione si raccomanda di salvare l’indirizzo MAC del dispositivo che si trova sulla scatola o sul retro della telecamera IP. Questo indirizzo verrà richiesto durante la fase di associazione all’interno del cloud, del dispositivo alla centrale.

**Indirizzo MAC**



## Montaggio della telecamera IP

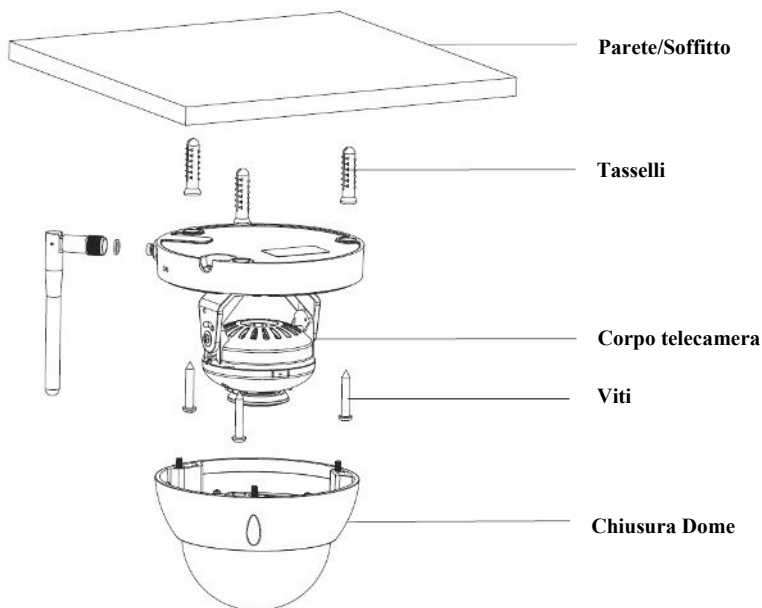

**Figura 4 Montaggio**

**IMPORTANTE** - Si prega di assicurarsi che la superficie di installazione possa supportare almeno 3 volte il peso della telecamera comprensiva di staffa.

Passo	Descrizione
1	Posizionare la dima in dotazione sulla superficie dove si è previsto di installare la telecamera. (soffitto o parete).
2	Fare i buchi sulla superficie di installazione utilizzando la dima come riferimento.
3	Inserire i tasselli (in dotazione) nei fori appena fatti.
4	Posizionare la base della staffa sui fori.
5	Utilizzate un cacciavite per stringere le viti (in dotazione) e fissare fermamente la base della staffa.
6	Allentare la vite di regolazione e ruotare la telecamera IP nella posizione corretta in base alle vostre esigenze.

Passo	Descrizione
	<ul style="list-style-type: none"> <li>• Se il cavo viene portato dalla parte superiore della superficie di installazione, effettuare un buco in corrispondenza dell'indicazione presente sulla dima.</li> <li>• Se il cavo viene portato lateralmente, dovrà essere fatto passare dalla scanalatura a forma di "U" sul supporto della telecamera. Fare passare il cavo dal foro di uscita presente sul supporto.</li> </ul>
7	Posizionare il supporto della telecamera nella posizione di installazione e fare passare il cavo dall'apposito foro di uscita.
8	Allineare l'indicatore TOP presente sul supporto della telecamera con quello presente sulla dima.
9	Allineare i tre fori presenti sul supporto con i tasselli indicati sulla dima.
10	Avvitare le tre viti ai tasselli.
11	Avvitare il corpo della telecamera sulla superficie di installazione.
12	Mantenere fermi entrambi i lati della staffa e ruotare orizzontalmente sull'asse il corpo della telecamera regolando le lenti.
13	Regolare il coperchio LED nella posizione desiderata. Se troppo stretto per regolarlo, allentare le viti ai lati della staffa (senza rimuoverle), quindi stringerle nuovamente dopo la regolazione.
14	<p>Mantenendo il coperchio LED, ruotarlo sull'asse regolandolo per ottenere la copertura desiderata.</p> <p><b>Range delle lenti:</b></p> <ul style="list-style-type: none"> <li>• verticale (<math>0^{\circ} \sim +64^{\circ}</math>)</li> <li>• orizzontale (<math>0^{\circ} \sim +355^{\circ}</math>)</li> <li>• rotazione immagine (<math>0^{\circ} \sim +355^{\circ}</math>)</li> </ul> <p><b>NOTA</b> – quando la rotazione è <math>64^{\circ}</math> in direzione verticale, fare attenzione alla direzione di rotazione immagine evitando di andare a bloccare la luce IR sul guscio esterno.</p>

## Alimentazione della Telecamera IP

1. Connettere l'alimentazione all'apposito ingresso della Telecamera IP.
2. Collegare l'alimentatore ad una presa elettrica. Quando la telecamera si accende, il LED VERDE verrà acceso.

## Connessione della telecamera IP al RISCO Cloud

La telecamera IP supporta la connessione di rete LAN e WiFi.

### Connessione ad una rete LAN

Il collegamento della telecamera IP a una rete tramite LAN (Local Area Network) consente di effettuare una connessione e configurazione semplice del dispositivo.

1. Collegare il cavo di rete in ingresso alla porta di rete sulla telecamera IP.
2. Attendere che il led Verde smetta di lampeggiare ad indicare che la telecamera si sia connessa alla rete. Procedere come indicato.

### Connessione ad una rete Wireless usando la WPS

Per connettere la telecamera IP ad una rete Wifi usando il sistema WPS (Wi-Fi Protected Setup) si richiede che il router supporti questa funzione.

---

**NOTA** – Alcuni router hanno un tasto virtuale nella propria pagina di gestione (fare riferimento alla documentazione del router per maggiori informazioni).

---

1. Quando l'alimentatore è connesso, attendere che il led verde inizi a lampeggiare.
2. Premere il tasto WPS sulla telecamera e tenere premuto il tasto WPS sul router per 2 secondi. Il led verde acceso vi indicherà che la connessione alla rete è avvenuta con successo. Proseguire come indicato al paragrafo Impostazioni Telecamera.

### Connessione ad una rete Wireless tramite Cloud RISCO

Connettere la telecamera IP al RISCO Cloud richiede che la telecamera sia stata precedentemente connessa al router per potere poi dal Profilo Installatore definire i parametri e abilitare la connessione Wireless. Quando la connessione Wireless è stata instaurata, la telecamera può essere scollegata dalle porte LAN e installata nella posizione finale.

1. Connettere il cavo LAN alla telecamera.
2. Attendere che il led verde indichi che la connessione sia avvenuta con successo (acceso fisso). Seguire le istruzioni riportate nel paragrafo Impostazioni Telecamera di seguito descritto.
3. Quando la connessione Wireless è stata instaurata, la telecamera può essere scollegata dal router e installata nella posizione finale.

## Telecamera IP e Profilo Installatore

Il Profilo Installatore è un interfaccia accessibile da PC attraverso Web browser. Questo Profilo è l'interfaccia attraverso la quale è possibile aggiungere le telecamere IP, definendone i comandi di attivazione, alle centrali installate e connesse su Cloud.

**IMPORTANTE** – Affinché si possano definire i comandi di attivazione (trigger) della telecamera è necessario che questa sia associata ad una centrale RISCO. Fare anche riferimento al manuale installatore del Cloud RISCO

### Impostazioni Telecamera

Quando la telecamera è stata connessa alla rete, è possibile definirne i parametri.

#### Impostazioni Telecamera:

1. Autenticarsi nel proprio Profilo Installatore via web inserendo le proprie credenziali.

**NOTA** – E' consigliabile utilizzare Google Chrome o Mozilla Firefox per eseguire le seguenti operazioni.

2. Selezionare la voce Lista Centrali.



Figura 5 Pagina Lista Centrali

3. Dalla pagina Lista Centrali, selezionare la centrale sulla quale si desidera operare.

**Figura 6 Aggiornamento Centrale**

4. Selezionare Telecamere IP dal menu a sinistra.

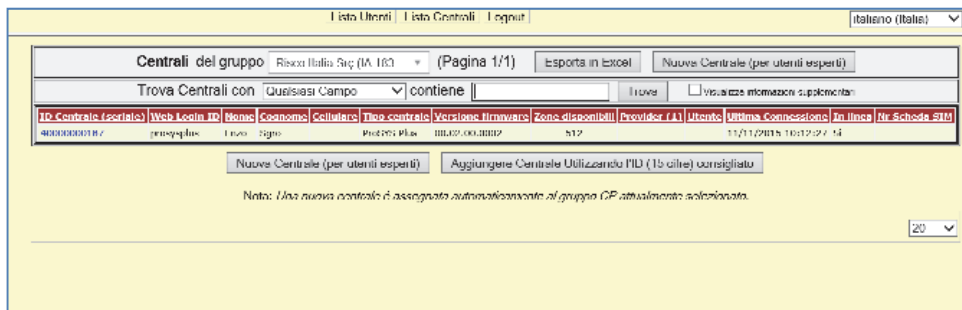
**Figura 7 Telecamere IP**

5. Selezionare Aggiungi Telecamera.

**Figure 8 Aggiungi Telecamera**

6. Compilare i seguenti campi della finestra Aggiungi Telecamera.

Campo	Descrizione
<b>Etichetta</b>	Etichetta della telecamera
<b>Partizioni</b>	Selezionare le partizione(i) a cui associare la telecamera
<b>Tipo</b>	Selezionare RISCO P2P se si utilizza una telecamera VuPoint (per le telecamere Onvif fare riferimento al relativo manuale/bollettino tecnico)

<b>MAC Address</b>	<p>Inserire il MAC Address. Il MAC Address è un indirizzo identificativo univoco assegnato in fabbrica alla telecamera.</p> <p><b>NOTA:</b> L'indirizzo MAC tiene conto delle lettere maiuscole e minuscole e quindi andrà digitato come riportato sull'etichetta, es: AA:BB:CC:DD:EE:FF.</p>
--------------------	---

7. Selezionare Aggiungi.

Se viene mostrato il messaggio “Connetti al WiFi” passare al punto 8.



**Figura 9 Connetti al WiFi**

---

**NOTA** – Questo messaggio è mostrato solo se la telecamera è connessa via cavo al router.

---

8. Selezionare una delle seguenti opzioni:

**Connetti al WiFi** – per connettersi alla rete wireless (passare al punto 9 per connettere la telecamera al WiFi).

**Non ora** – per utilizzare la connessione LAN (saltare i passaggi 9, 10, 11 e connettere la telecamera via cavo)

9. Se si è selezionata l’opzione “Connetti al WiFi”, verrà mostrata la lista delle reti WiFi disponibili rilevate dalla telecamera.



**Figura 10 Lista delle reti WiFi**

10. Selezionare una rete da quelle disponibili e cliccare l'opzione Connetti.

**NOTA** – Se la rete è protetta da password, sarà necessario inserirla nell'apposita finestra.

11. Selezionare OK per instaurare la connessione via WiFi.

**IMPORTANTE** – Ricordarsi di rimuovere il cavo LAN dalla telecamera nel caso si utilizzi la connessione WiFi.

Nel caso in cui la telecamera perda la connessione WiFi (es: router guasto) sarà necessario riconnettere il cavo LAN per ripristinare la connettività e potere cambiare la rete WiFi di riferimento.

12. Quando si è terminata la configurazione selezionare OK. La telecamera verrà mostrata nella lista delle telecamere IP associate alla centrale.

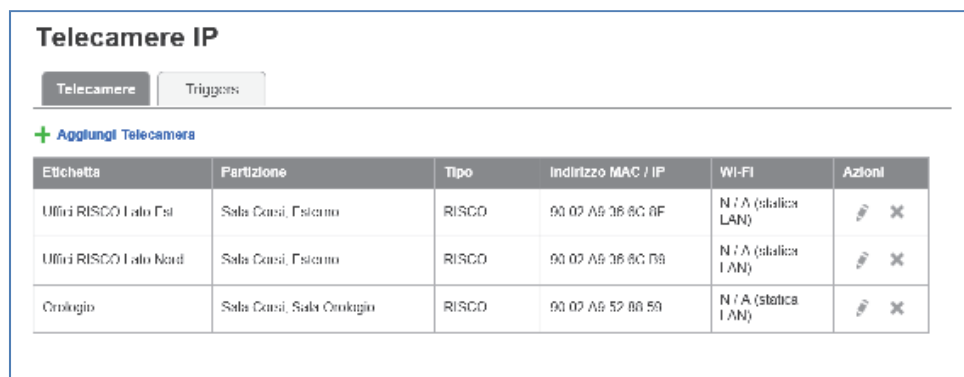

**Telecamere IP**

Telecamere Triggers

+ Aggiungi Telecamera







Etichetta	Partizione	Tipo	Indirizzo MAC / IP	WI-FI	Azioni
Uffizi RISCO 1 alo Est	Sala Cusi, Esterno	RISCO	90 02 AB 36 8C 8F	N / A (statica LAN)	 
Uffizi RISCO 1 alo Nord	Sala Cusi, Esterno	RISCO	90 02 AB 36 8C 88	N / A (statica LAN)	 
Orologio	Sala Cusi, Sala Orologio	RISCO	90 02 AB 52 80 59	N / A (statica LAN)	 

Figura 11 Lista telecamere IP

**NOTA** – Sarà possibile editare i parametri della telecamera  o cancellarla  anche in un secondo momento.

### Accedere al web server della telecamera via rete Lan

Dopo avere assegnato la telecamera alla centrale attraverso il Profilo Cloud Installatore, sarà necessario abilitare l'accesso locale via web nel caso in cui sia necessaria questa funzionalità. Per far questo accedere al menù Telecamere IP della centrale e cliccare il pulsante . Da questo menù sarà possibile abilitare il parametro "UI/CGI" come di seguito illustrato. Il parametro "UI/CGI" verrà disabilitato automaticamente dopo 60 minuti.

## Telecamere IP





Etichetta	Partizione	Tipo	Indirizzo MAC / IP	Wi-Fi	Azioni
Dome p2p	PARTIZIONE 1	RISCO P2P Camera	3C:EF:8C:F8:9C:5F	WIFI-0B9D02	  FW ...
cube p2p	PARTIZIONE 1	RISCO P2P Camera	3C:EF:8C:DF:6C:5F	Collega	  FW ...

Figura 12 Selezione il menu Accesso Locale Telecamera 



Accesso Locale Telecamera

FW Versione: 2.400.0000.2.R 2016-10-28

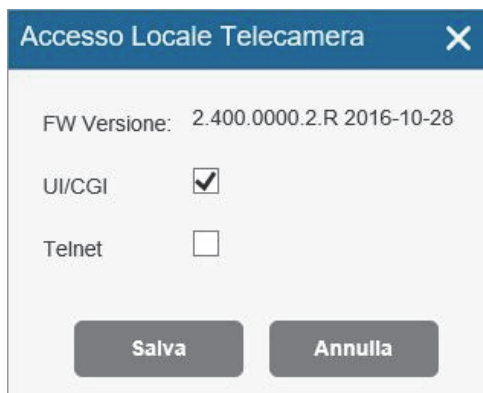
UI/CGI

Telnet

Salva Annulla

Figura 13 Abilitare il parametro UI/CGI

## Aggiornamento Firmware Telecamera

Nel caso in cui venga rilasciato un firmware di aggiornamento della telecamera, sarà possibile avviare l'aggiornamento tramite dal menù Telecamere IP della centrale, cliccando il pulsante **FW** e selezionando il tasto "Aggiornamento Firmware" che verrà mostrato solo nel caso in cui sia disponibile un aggiornamento.



Aggiornamento Firmware

Versione FW corrente: 2.400.0000.3.R

Nuova versione FW: N/A

Stato aggiornamento FW: La telecamera ha l'ultimo firmware disponibile.

Chiudi

Figura 14 Finestra Aggiornamento Firmware

## Comandi di attivazione (Trigger) Telecamere IP

Tutti gli eventi di seguito elencati possono essere programmati per attivare la telecamera IP.

Segue Partizione			
Allarme Incendio	Allarme Panico	Allarme Medico	Allarme
Inserito Totale	Inserito Parziale	Disinserito	Coercizione
Tamper	Allarme 24 HR-X	Allarme Allagamento	Allarme Gas
Allarme Ambientale	Allarme Nessun Movimento	Allarme Uscita	Alta o Bassa Temperatura
Segue Sensore			
Allarme	Zona Esclusa	Zona Re-inclusa	Tamper Zona

### Per impostare i comandi di attivazione (trigger):

1. Dalla pagina Telecamere IP della centrale, selezionare la voce Aggiungi Trigger e verrà mostrata la relativa finestra.



Figura 15 Aggiungi Trigger

2. Selezionare Aggiungi Trigger, verrà mostrata la seguente finestra.

The screenshot shows a dialog box titled 'Aggiungi nuovo trigger' with a close button (X) in the top right corner. The dialog is divided into two main sections. The left section contains five form fields: 'Etichetta:' (text input), 'Telecamera:' (dropdown menu with 'Select...' option), 'Tipo di evento:' (dropdown menu with 'Segue Partizione' selected), 'Partizioni:' (dropdown menu with 'Selezionare le partizioni' selected), and 'Evento:' (dropdown menu with 'Select...' option). The right section is titled 'Immagini' and contains three rows of settings, each with a minus button, a numeric input field, and a plus button: 'Inizio Pre-evento (sec):' with '2', 'Numero di immagini:' with '5', and 'Intervallo tra le immagini (sec):' with '1.0'. Below this section is a section titled 'clip' with a checkbox that is currently unchecked. Underneath the 'clip' section are two more rows of settings: 'Inizio Pre-evento (sec):' with '5' and 'Durata (sec):' with '30'. At the bottom right of the dialog, there are two buttons: 'Annulla' and 'Fatto'.

Figura 16 Nuovo Trigger

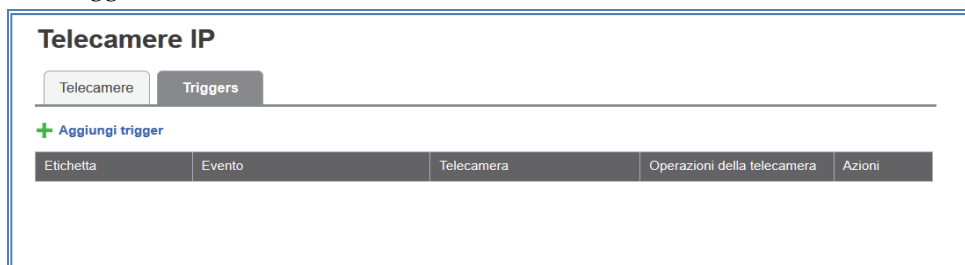
### 3. Compilare i seguenti campi:

Campo	Descrizione	Tipo evento
<b>Etichetta</b>	Nome del Trigger	
<b>Telecamera</b>	Selezionare a quale telecamera associare il trigger	
<b>Tipo di evento</b>	Selezionare il tipo di evento	Partizione o Sensore
<b>Evento</b>	Selezionare l'evento	

La scheda Aggiungi Trigger contiene opzioni aggiuntive a seconda del tipo di evento che si è scelto (la tipologia Partizione o Sensore).

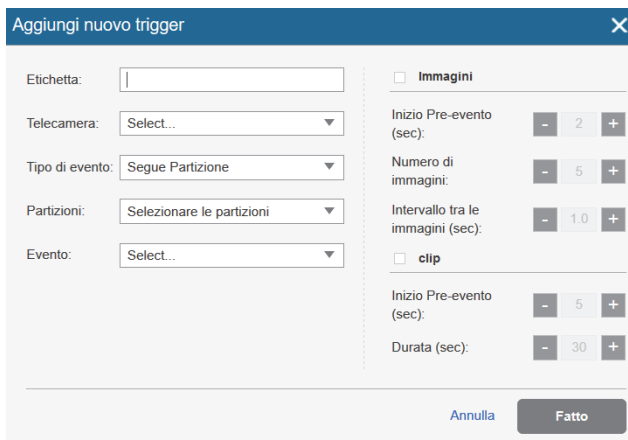

Figura 17 Partizione

Figura 18 Sensore

### 4. Effettuare le selezioni a seconda del tipo di evento scelto.

Campo	Descrizione	Tipo Evento
<b>Partizione(i)</b>	Selezionare la partizione(i) dalla lista. <b>NOTA</b> – Solo le partizioni associate alla telecamera sono mostrate	Partizione
<b>Sensori</b>	Selezionare i sensori dalla lista	Sensore

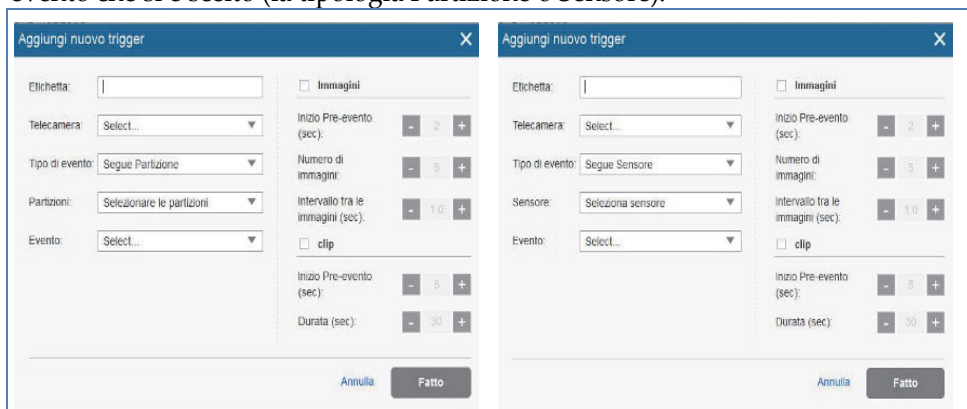
### 5. Programmare i seguenti parametri per le immagini (fotogrammi) e le clip (video):

Campo	Descrizione
<b>Immagini (fotogrammi)</b>	<b>Inizio Pre-evento (sec)</b> – lasso di tempo, precedente all'evento che si verifica, per il quale includere i fotogrammi. <b>Numero di immagini</b> – quantità di immagini. <b>Intervallo tra le immagini (sec)</b> – tempo che intercorre tra le immagini.

<b>Clip (video)</b>	<p><b>Inizio Pre-evento (sec)</b> – lasso di tempo, precedente all’evento che si verifica, per il quale includere il video (5 secondi)</p> <p><b>Durata (sec)</b> – durata totale (30 secondi)</p> <p><b>NOTA</b> – questi due parametri sono fissi, generando una clip di 25 sec + 5 sec.</p>
---------------------	--

**NOTA:** Per abilitare la funzione di registrazione delle clip video assicurarsi di aver inserito una SD card spegnendo e poi rialimentando la telecamera.

- Una volta terminato, selezionare “Fatto”. I comandi Trigger programmati verranno mostrati nella finestra Trigger.

### Telecamere IP

Telecamere

Triggers

+ Aggiungi trigger

Etichetta	Evento	Telecamera	Operazioni della telecamera	Azioni
Allarme Zona 2	Sensore - PORTONE INGRESSO Segue Allarme	Uffici RISCO Lato Nord	7 Immagini	
ALLARME CLIP	Sensore - TAPP SALA Segue Allarme	Orologio	30 secondi clip	

**Figura 19 Lista Trigger**

**NOTA** – Sarà comunque possibile editare , creare o duplicare , oppure cancellare il trigger selezionato.

**IMPORTANTE** – Due trigger non possono essere identici. Se viene duplicato un trigger andrà modificato l’evento o la telecamera ad esso associati.

## Specifiche Tecniche

<b>Modello</b>	<b>RVCM32W0200A</b>	
<b>Telecamera</b>		
Sensore video	1/3" 1.3 Megapixel scan progressivo scan CMOS	
Pixels	1280(H) x960(V)	
Sistema Scanning	Progressivo	
Modo esposizione	Auto/Manuale, 1/3(4)~1/100000s	
Illuminazione min	0. 1Lux/F2.0(Colore), 0Lux/F2.0(IR acceso)	
S/N Ratio	Più di 50dB	
Uscita Video	N/A	
<b>Caratteristiche Telecamera</b>		
Max. portata Illuminatore IR	30m	
Day/Night	Auto(ICR)/Colore/B/W	
BLC	BLC / HLC / DWDR	
Bilanciamento Bianco	Auto/Manuale	
Controllo analogico	Auto/Manuale	
Max. portata LEDs IR	3D	
Zone di mask	Supporta un massimo 4 zone di mascheramento immagine	
<b>Lenti</b>		
Lunghezza Focale	3.6mm	
Apertura Massima	F2.0(F2.0)	
Controllo Focus	Manuale	
Angolo Visuale	H: 72°(92°)	
Tipo Lenti	Lente fissa	
Montaggio Lente	Integrato	
<b>Video</b>		
Compressione	H.264/H.264H/H.264B/MJPEG	
Risoluzione	1.3MP(1280×960)/720P(1280×720)/ VGA(640×480)/QVGA(320×240)	
Frame Rate	Main Stream	1.3MP/720P(1 ~ 25/30fps)
	Sub Stream	VGA/QVGA(1 ~ 25/30fps)
Bit Rate	H.264: 32kbps~8192kbps	
Modo corridoio	Supportato	
<b>Audio</b>		
Compressione	N/A	
Interfaccia	N/A	
<b>Rete</b>		
Ethernet	RJ-45 (10/100Base-T)	
Wi-Fi	Wi-Fi(IEEE802.11b/g/n) 50m (campo aperto)	
Protocollo	P2P, IPv4/IPv6, HTTP, HTTPS, TCP/IP, UDP, UPnP, ICMP, IGMP, RTSP, RTP, SMTP, NTP, DHCP, DNS, PPPOE, DDNS, FTP, IP Filter, QoS	

Compatibilità	ONVIF, CGI
Max. Numero utenti	20 utenti
Smartphone	iPhone, iPad, Android
<b>Interfaccia Ausiliaria</b>	
Slot Memoria	Micro SD card, fino a 128GB
RS485	N/A
Allarme	N/A
Range Sensore PIR	N/A
<b>Generali</b>	
Alimentatore	DC 12V
Assorbimento	<4.6W (IR attivo)
Frequenza e Potenza	2412 – 2462 MHz, 0.0215 W 2422 – 2452 MHz, 0.0095 W
Temperatura di esercizio	-30°C~+50°C, meno di 95% RH
Grado protezione	IP67
Protezione Anti-Vandalismo	N/A
Dimensione	Φ110mm×81mm
Peso	0.55Kg con imballo



# VUpoint

## Cámara IP Dome P2P a prueba de vandalismo



**Modelo: RVCM32W**

ES



<http://VUpoint-P2P.riscogroup.com/How-to-Install/>

## Guía de instalación

## Precauciones de seguridad

Estas instrucciones están indicadas para asegurar que el usuario puede utilizar el producto correctamente para evitar daños personales o materiales.

### ADVERTENCIAS:

- La instalación o el uso de este producto que se realice de acuerdo con el uso indicado por el proveedor y, tal y como está descrito en las instrucciones, puede causar daños, lesiones o la muerte.
- Asegúrese de que no tienen acceso a este producto niños y aquellas personas para quienes no esté destinado el uso del sistema.
- Toda la instalación y la operativa debe ser conforme a sus normas de seguridad eléctrica. La alimentación debe cumplir con el requisito de tensión mínima de seguridad SELV (Safety Extra Low Voltage) y la fuente de alimentación limitada tiene un valor de 12V DC según la norma IEC60950-1.
- Si el dispositivo está conectado permanentemente a la red eléctrica, la conexión debe incluir un dispositivo de desconexión de fácil acceso, por ejemplo, un interruptor. No conecte dos fuentes de alimentación al dispositivo a la vez, ya que puede ocasionar daños al dispositivo.
- No intente bajo ningún concepto reparar el dispositivo por su cuenta, ya que podría causar daños, lesiones o la muerte. Póngase siempre en contacto con su instalador o proveedor para cualquier avería.

### ATENCIÓN:

- Asegúrese de que el voltaje de la alimentación es el adecuado antes de usar la cámara.
- No deje caer la cámara ni la someta a ningún tipo de impacto.
- No toque los sensores con los dedos. Si es necesario limpiarlos, use un trapo limpio mojado ligeramente en alcohol y úselo cuidadosamente.
- No oriente la lente de la cámara a una fuente de luz potente como el sol o una lámpara incandescente. La luz intensa puede causar daños irreparables a la cámara.
- El sensor se puede quemar por el uso de un láser, por este motivo si se va a emplear cerca de la cámara cualquier equipamiento que disponga de láser, asegúrese de que la superficie del sensor no está expuesta al mismo.
- No instale la cámara en entornos de temperatura extremos (la temperatura de operación se debe encontrar entre el rango -10 °C - +50 °C).
- Para evitar el sobrecalentamiento de la cámara, se recomienda utilizarla en un entorno que disponga de una buena ventilación.
- Durante su distribución, la cámara debe estar empaquetada en su embalaje original.

**NOTA:** no se asume ningún tipo de responsabilidad derivada de cualquier tipo de fuego o daño eléctrico o electrocución fruto de un manejo o instalación incorrectos. No se asume ningún tipo de responsabilidad causada por modificaciones o intentos de reparaciones no autorizadas.

## Introducción

RISCO Group presenta VUpoint, una revolucionaria solución de videoverificación que integra fácilmente cámaras IP con los sistemas de seguridad profesional de RISCO. Impulsado por RISCO Cloud (Servidor de la aplicación RISCO), VUpoint proporciona un nivel de seguridad y videoverificación en vivo sin precedentes para centrales receptoras y usuarios finales por igual. La cámara IP Dome de interior y exterior de RISCO es una parte importante de esta solución y se puede controlar fácilmente a través de aplicaciones web y dispositivos móviles.

## Características

- Instalación Plug & Play
- 1,3 megapíxeles
- Color HD
- Día/Noche
- Alcance del LED IR: 30 m

## Componentes y accesorios

Cámara IP RISCO y soporte:

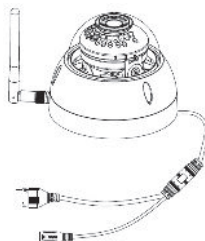

### VUpoint

Cámara IP Dome P2P a prueba de vandalismo



Modelo: DVCM32W

Guía de instalación

Guía de instalación:

## Componentes y dimensiones de la cámara IP



Figura 1 Vista externa y puertos

Etiqueta	Nombre
1	Cubierta abovedada
2	Caja abovedada
3	Puerto de red
4	Puerto de alimentación

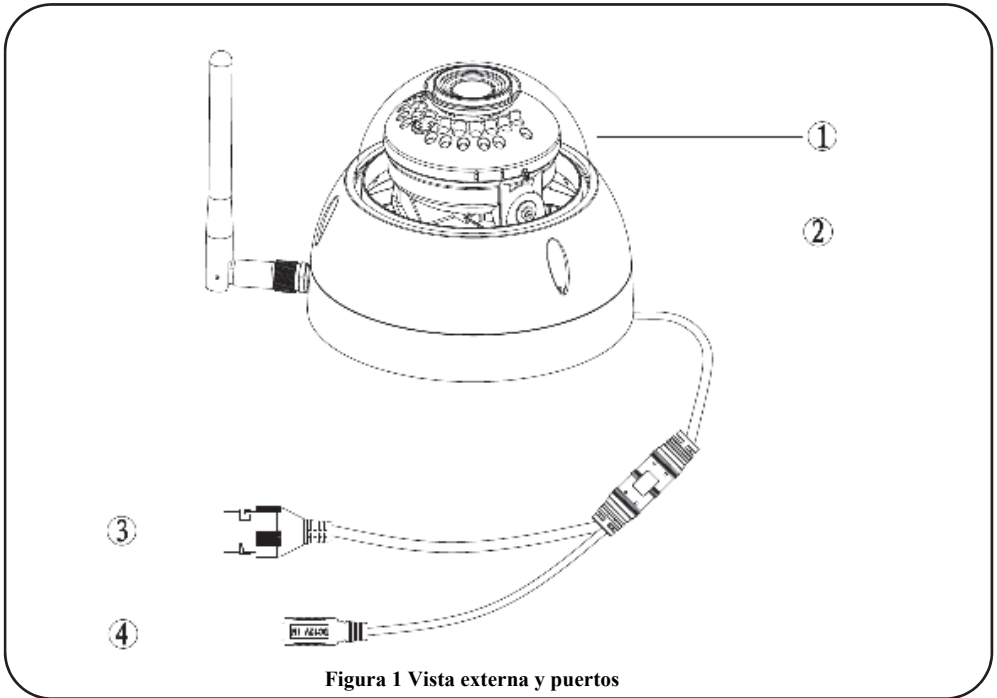
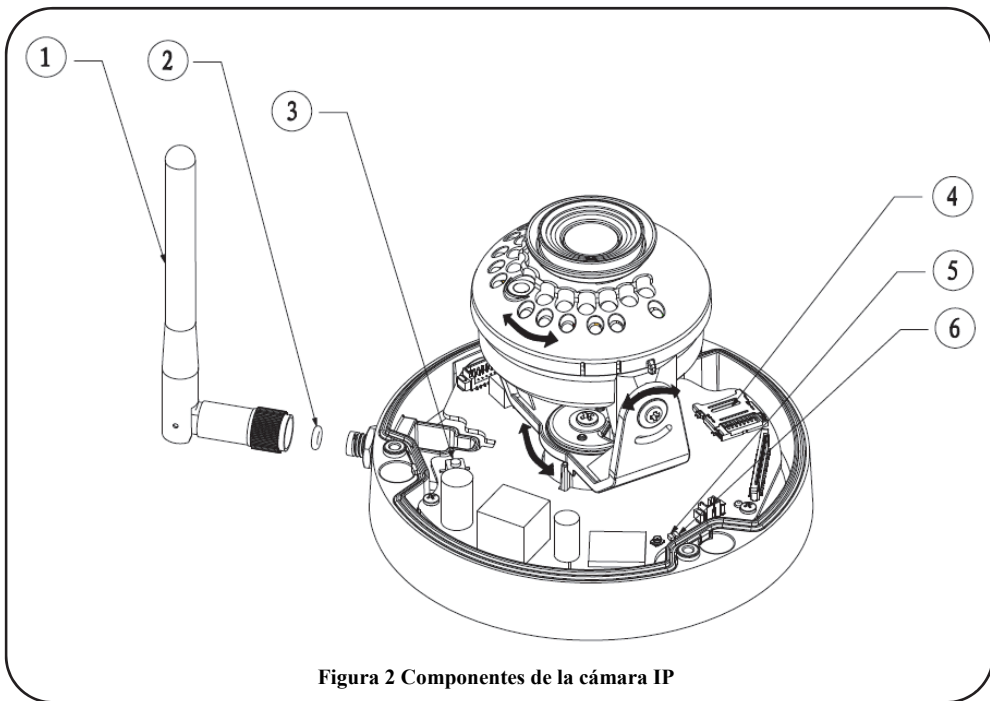

**Figura 2 Componentes de la cámara IP**

Etiqueta	Nombre
1	Antena inalámbrica
2	Junta estanca
3	Botón Reset/WPS
4	Ranura para tarjeta Micro SD
5	Indicador 1
6	Indicador 2

**Nota:**

- Para realizar el Reset, mantenga presionado el botón durante 15 segundos y la luz se apagará
- Para WPS, pulse rápidamente una sola vez.

Indicación	Significado
Rojo fijo	Arrancando
Verde con parpadeo lento	La cámara IP no está conectada a RISCO Cloud. Compruebe la conexión a Internet y reinicie la cámara IP para intentar volver a conectarla.
Verde con parpadeo rápido	Config inteligente de WiFi en curso, incluido WPS, marco de gestión, etc.
Verde fijo	La cámara IP está conectada correctamente a RISCO Cloud.
Verde y rojo con parpadeo alterno	Actualización del dispositivo
Rojo con parpadeo lento	Error de conexión de red o desconexión tras una conexión de red correcta.
Rojo con parpadeo rápido	Error de funcionamiento del dispositivo, error de arranque, error de alarma o de tarjeta SD



Figura 3 Dimensiones de la cámara IP

## Instalación de la cámara IP

Después de leer las instrucciones de instalación y antes de instalar su cámara IP, planifique el montaje de la misma en la localización elegida. La correcta colocación de su cámara IP es crucial para un rendimiento óptimo de la monitorización. En primer lugar, determine qué áreas deben ser protegidas y seguidamente planifique cuáles son las zonas óptimas para instalar su cámara IP.

**IMPORTANTE:** es muy importante anotar la dirección MAC visible en la caja o en la cubierta trasera de la cámara IP antes de la instalación. Podría necesitarla durante la fase de conexión a la red.

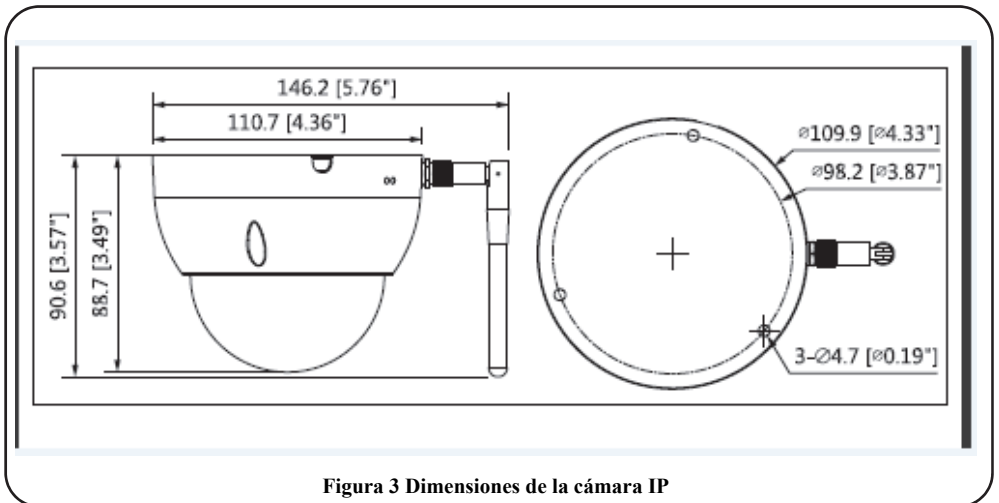
Dirección  
MAC



## Montaje de la cámara IP



Figura 4 Montaje

**IMPORTANTE:** asegúrese de que la superficie de instalación puede soportar como mínimo 3 veces el peso de la cámara y del soporte.

Paso	Descripción
1	Utilice la llave hexagonal suministrada para abrir la caja abovedada aflojando los tres tornillos hexagonales interiores.
2	Coloque la plantilla de instalación en la superficie del techo o pared.
3	Realice los agujeros en la superficie de acuerdo con la plantilla.
4	Inserte los tres tacos en los agujeros.
5	Coloque la base de la cámara IP sobre los agujeros.
6	Saque de la bolsa de accesorios los tornillos y atornille la cámara IP firmemente.

Paso	Descripción
	<ul style="list-style-type: none"> <li>• Si lleva el cable desde la parte superior de la superficie de instalación, haga un agujero de salida en la superficie según la plantilla de instalación.</li> <li>• Si lleva el cable desde el lateral del canal de cables, debe pasar por el canal en forma de U del soporte. Saque el cable del lateral del agujero de salida ubicado en el soporte.</li> </ul>
7	Ajuste el soporte de instalación del dispositivo en la posición correcta y pase el cable por el agujero de salida ubicado en la superficie de instalación.
8	Alinee la marca SUPERIOR del soporte de instalación del dispositivo con la marca de la plantilla de instalación.
9	Alinee los tres agujeros del soporte del dispositivo con los tres agujeros de los tacos de plástico de la plantilla de instalación.
10	Fije con firmeza los tornillos en los tres tacos de plástico.
11	Fije el cuerpo abovedado a la superficie de instalación.
12	Sostenga los dos lados de la base del soporte de rotación, gire horizontalmente a lo largo del eje y ajuste la lente en dirección horizontal con la posición elegida.
13	<p>Sostenga la tapa LED y gírela verticalmente mientras ajusta la lente en dirección vertical con la posición elegida.</p> <p>Si está demasiado apretado para ajustar, afloje primero los tornillos de ambos lados del soporte (no quite los tornillos fijos) y después ajuste la lente y vuelva a apretar los tornillos.</p>
14	<p>Sin soltar la tapa LED, gire alrededor del eje y ajuste la imagen de la lente en la posición de vigilancia adecuada.</p> <p><b>Alcance de la lente:</b></p> <ul style="list-style-type: none"> <li>• vertical (<math>0^{\circ}\sim+64^{\circ}</math>)</li> <li>• horizontal (<math>0^{\circ}\sim+355^{\circ}</math>)</li> <li>• dirección de rotación de la imagen (<math>0^{\circ}\sim+355^{\circ}</math>)</li> </ul> <p><b>NOTA:</b> cuando la rotación es de <math>64^{\circ}</math> en la dirección vertical, preste atención a la dirección de rotación de la imagen para evitar el bloqueo de la luz IR con la tapa exterior, ya que esto podría afectar negativamente al efecto IR.</p>

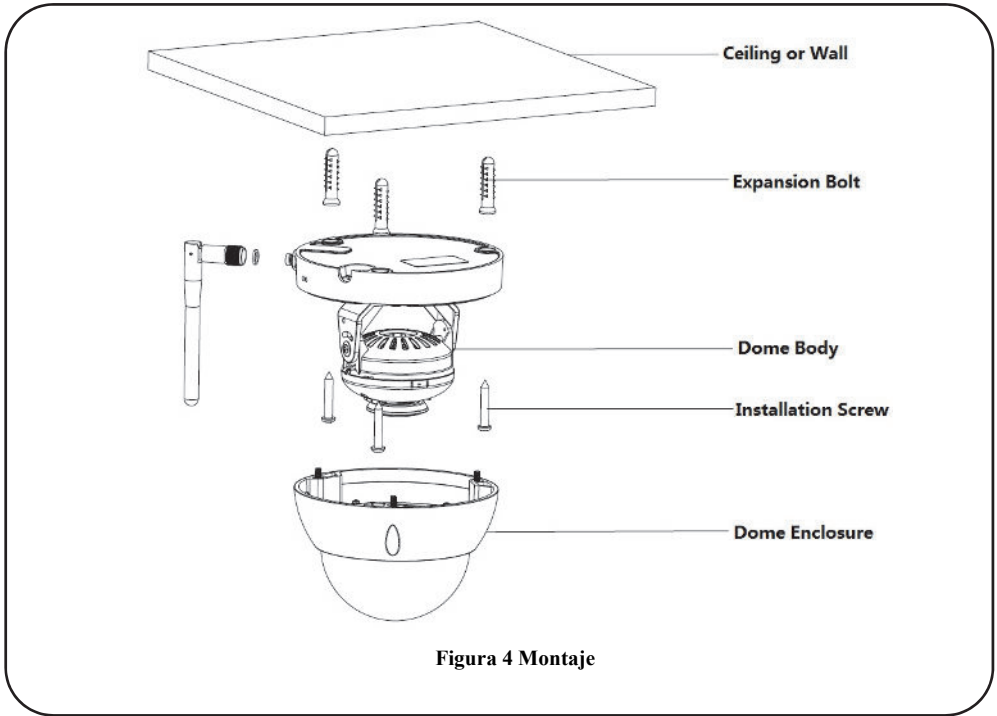
## Alimentación de la cámara IP

1. Conectar el adaptador de corriente al puerto de alimentación de la cámara IP.
2. Conectar el adaptador de corriente a una toma eléctrica. Cuando la cámara IP arranque, el indicador de alimentación VERDE parpadea.

## Conectar la cámara IP a la red

La cámara IP soporta varias opciones de conexión de red, incluidas redes locales cableadas y redes inalámbricas.

### Conectarse a una red local cableada

Conectar la cámara IP a una red a través de la red LAN (Red de Área Local) permite conectar y configurar fácilmente puntos de acceso compatibles, por ejemplo, puertas de enlace o routers.

1. Conectar el cable de red entrante al puerto de red de la cámara IP.
2. El indicador de red VERDE muestra que la cámara IP ya está conectada a la red. Continúe con la sección Definir la configuración de la cámara IP.

### Conectarse a una red inalámbrica con WPS

Conectar la cámara IP a una red inalámbrica con WPS requiere que el router soporte la funcionalidad WPS.

---

**NOTA:** algunos routers tienen un botón virtual en su software de gestión. (Consulte la documentación del router para saber más sobre sus funciones WPS).

---

1. Una vez conectado el cable de alimentación, espere a que el indicador de red VERDE parpadee lentamente.
2. Mantenga presionado el botón WPS de la cámara IP y el botón WPS del router durante 2 segundos. El indicador de red VERDE muestra que la cámara IP ya está conectada a la red. Continúe con la sección Definir la configuración de la cámara IP.

## **Conectarse a una red inalámbrica con RISCO Cloud**

Para conectar la cámara IP a una red inalámbrica con RISCO Cloud (Servidor de la aplicación RISCO) es preciso conectar primero la cámara IP al router a través de la red LAN y, después, desde la Aplicación para instaladores de RISCO Cloud, definir los ajustes de la cámara IP y establecer una conexión inalámbrica. Una vez establecida la conexión inalámbrica, se puede desconectar la cámara IP del router e instalarla/montarla.

1. Conectar el cable de red entrante al puerto de red de la cámara IP.
2. El indicador de red VERDE muestra que la cámara IP ya está conectada a la red. Continúe con la sección Definir la configuración de la cámara IP.

---

**NOTA:** antes de desconectar la cámara, puede configurar la red inalámbrica a través de RISCO Cloud.

---

3. Una vez establecida la conexión inalámbrica, puede desconectar la cámara IP del router e instalarla/montarla dentro de la zona supervisada.

# Cámaras IP y la Aplicación para instaladores de RISCO Cloud

La aplicación para instaladores de RISCO Cloud ofrece una interfaz al panel de control desde un ordenador local o remoto vía Internet. Esto permite añadir cámaras IP y definir ajustes de trigger de alarma de eventos y de cámaras.

**IMPORTANTE:** debe haber definido primero un panel de control en RISCO Cloud para poder aceptar cámaras IP y configurar los ajustes de la cámara (consulte el manual de la aplicación para instaladores de RISCO Cloud).

## Definir la configuración de la cámara IP

Una vez conectada la cámara IP a la red (consulte la sección Conectar la cámara IP a la red), puede definir la configuración de la cámara.

**Para definir la configuración de la cámara IP:**

1. Conéctese a la aplicación de administración de instaladores desde la página web suministrada por su proveedor de servicios e introduzca su nombre de usuario y contraseña.

**NOTA:** es recomendable usar Google Chrome o Mozilla Firefox para conectarse a la aplicación de administrador de instaladores.

2. Seleccione el vínculo **Control Panels List**. Se visualizará la página **Control Panels List**.

CP Login ID	Web Login ID	First Name	Last Name	Cell Phone	Provider (1st)	Account	Last Connected Time	Online?
TCONNECT203							7/17/2012 9:39:48 AM	No
2240000123							4/19/2012 5:34:47 PM	No
22400048768								Never
22400036472							5/14/2012 3:26:34 PM	No
22400000014							4/25/2012 9:00:11 AM	No
22400065764							5/21/2012 3:25:56 PM	No
22400000010							4/30/2012 1:11:16 PM	No
22400066013							5/2/2012 4:55:14 PM	No
22400000012							9/27/2012 1:01:38 PM	No
22400065725							9/19/2012 12:27:16 PM	No

Figura 5 Página Control Panels List

3. Desde la página **Control Panels List**, seleccione el panel de control que desee visualizar. Se visualizará la página **Control Panels Update**.



Figura 6 Página Control Panel Update

4. Pulse **Network Cameras** en la columna de la izquierda y se abrirá la página **IP Camera List**.

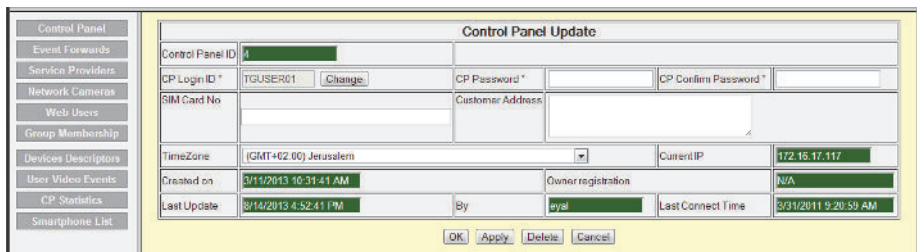

Figura 7 Lista de cámaras IP

5. Pulse **Add Camera**; se visualizará el cuadro de diálogo **Add Camera**.
6. Seleccione **RISCO P2P** como tipo de cámara.

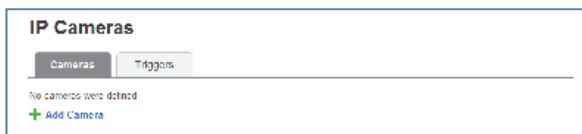

Figura 8 Add Camera

7. Defina los siguientes campos en el cuadro de diálogo **Add Camera**:

Campo	Descripción
<b>Label</b>	Especifique el nombre de la cámara
<b>Partitions</b>	Seleccione las particiones de la lista de particiones definidas
<b>Type</b>	Escoja RISCO P2P como tipo de cámara (para la configuración de tipos de cámaras ONVIF o cámaras genéricas, consulte el manual de la aplicación para instaladores de RISCO Cloud)

<b>MAC Address</b>	<p>Introduzca la dirección MAC en este campo. La dirección MAC (Media Access Control Address) es el identificador único asignado a la cámara IP para la comunicación en la red física.</p> <p><b>NOTA:</b> la dirección MAC distingue entre mayúsculas y minúsculas y se debe introducir exactamente como se muestra en la caja o en la etiqueta de la cámara IP, por ejemplo, AA:BB:CC:DD:EE:FF</p>
--------------------	--

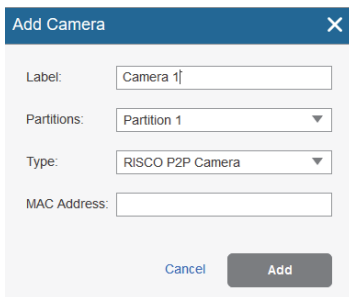
8. Pulse **Add**; aparecerá el siguiente mensaje.

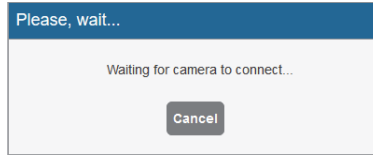

**Figura 9 Mensaje de espera de conexión de cámara**

Si se muestra el mensaje “Connect to WiFi”, vaya directamente al paso 9.

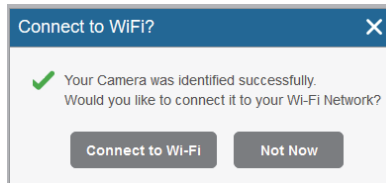

**Figura 10 Mensaje *Connect to WiFi***

9. Seleccione una de las opciones siguientes:

**Connect to Wi-Fi:** permite establecer una conexión de red inalámbrica (vaya al paso 9 para conectar la cámara IP a la red inalámbrica).

**Not Now:** permite establecer una conexión de red LAN (omite los pasos 10, 11 y 12 de la conexión a la red inalámbrica y conecte la cámara IP a la red LAN).

10. Si selecciona la opción **Connect to Wi-Fi**, aparecerá una lista con las redes inalámbricas disponibles.



**Figura 11** Lista de redes inalámbricas disponibles

11. Seleccionar una red inalámbrica en la lista disponible y pulsar **Connect**.

**NOTA:** si la red está protegida con contraseña, será preciso introducir una contraseña en la pantalla de contraseña.

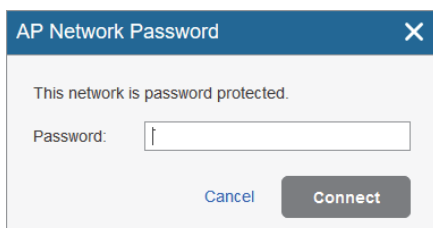

**Figura 12** Contraseña del Punto de Acceso

12. Pulse **Connect** para establecer la conexión inalámbrica (consultar Conectarse a una red inalámbrica con RISCO Cloud); aparecerá el siguiente mensaje.

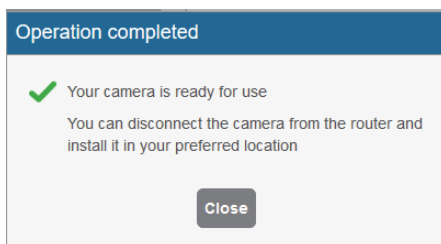

**Figura 13** Operación Completada

13. Cuando aparezca el mensaje *Camera is ready for use*, pulse **Close**. La cámara IP definida se visualizará en la página de cámaras IP.

**NOTA:** una vez establecida la conexión inalámbrica, no olvide desconectar el cable Ethernet de la cámara IP del router.

## IP Cameras

Label	Partition	Type	MAC Address	Wi-Fi	Actions
Main Entrance cam	Lobby Floor	RISCO	00-10-5A-44-12-B5	Connected	
Front yard cam	Lobby Floor, Storage Rooms	RISCO	00-10-2B-36-11-18	Connect	
Lobby cam	Lobby Floor	Generic	11-10-5A-44-12-B5	Connect	
Living Room	Storage Rooms	ONVIF	07-10-5A-4A-28-B6	Connected	
Second Floor north cam	Storage Rooms	ONVIF	00-10-5A-44-12-B5	Connected	
Basement	Sun Microsystems	RISCO	03-10-5A-44-12-B5	Connected	

Figura 14 Lista de cámaras IP

**NOTA:** también existe la opción de editar o eliminar la cámara IP seleccionada.

14. Pulse el botón **FW** de la sección **Actions** para comprobar si el firmware está actualizado.

## IP Cameras

Label	Partition	Type	MAC/IP Address	Wi-Fi	Actions
Cube - Office	Partition 1	RISCO P2P Camera	3C:EF:8C:DF:6C:59	Risco-Guest	

Figura 15 Actualización de firmware

La nueva versión del firmware se mostrará en la pantalla que se abre (si procede).



Figura 16 Nueva versión del firmware

## Definir la configuración de los triggers de la cámara

Cualquiera de los eventos de la lista que puede ver a continuación pueden definirse para activar un evento.

Eventos asociados a particiones			
Fire Alarm	Panic Alarm	Medical Alarm	Alarm
Full Arm	Part Arm	Disarmed	Duress
Tamper	24 HR-X Alarm	Water Alarm	Gas Alarm
Environ. Alarm	No Motion Alarm	Exit Alarm	Low Temperature
Eventos de detector			
Alarm	Zone Bypassed	Zone Un-bypassed	Zone Tamper

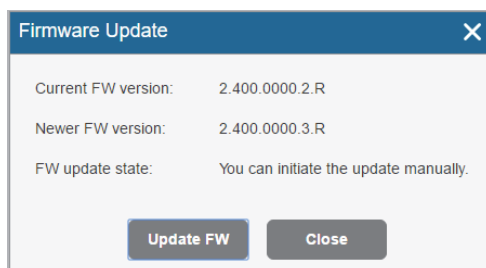
### Para definir la configuración de los triggers de la cámara:

1. En la página **Cameras** del panel de control, pulse la pestaña **Triggers**; se visualizará la página **Camera Triggers List**.



Figura 17 Lista de triggers de la cámara

2. Pulse **Add Trigger**; aparecerá el cuadro de diálogo **Add Triggers**.

Figura 18 Add Trigger

3. Defina los siguientes campos en el cuadro de diálogo **Add Trigger**:

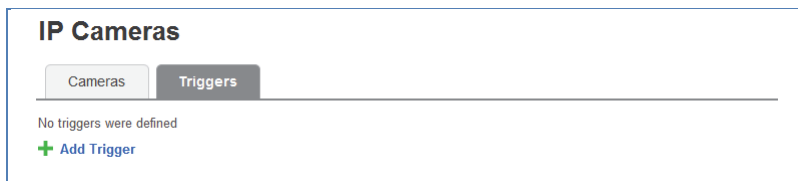
Campo	Descripción	Tipo de evento
<b>Label</b>	Especifique el nombre del trigger de la cámara	Eventos de partición y de detector
<b>Camera</b>	Elija una cámara de la lista	Eventos de partición y de detector
<b>Event Type</b>	Elija un tipo de evento de la lista	Eventos de partición y de detector
<b>Event</b>	Elija un evento de la lista.	Eventos de partición y de detector

El cuadro de diálogo **Add Trigger** puede incluir más campos en función del tipo de evento seleccionado (consulte los siguientes ejemplos de tipos de eventos de partición y de detector).



Figura 19 Añadir trigger de evento de partición

Figura 20 Añadir trigger de evento de detector

4. Defina los siguientes campos del cuadro de diálogo **Add Trigger** en función del tipo de evento seleccionado.

Campo	Descripción	Tipo de evento
<b>Partition(s)</b>	Seleccione las particiones de la lista. <b>NOTA:</b> solo se muestran las particiones asociadas a la cámara.	Solo eventos de partición
<b>Detectors</b>	Seleccione el detector de la lista.	Solo eventos de detector

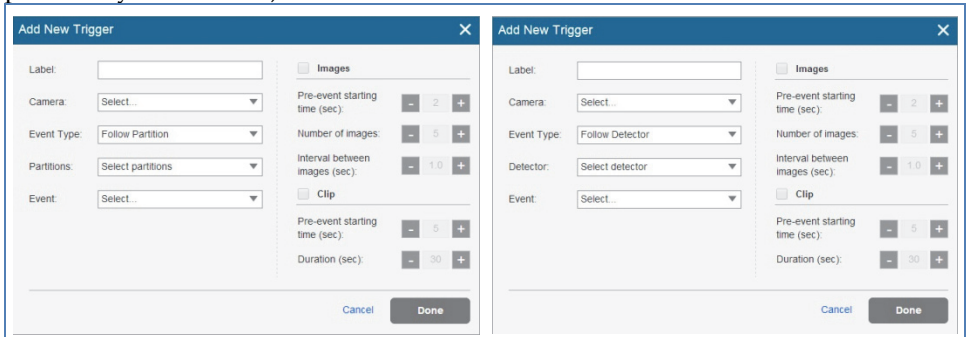
5. Defina las siguientes definiciones de imagen (estática) y clip (vídeo):

Campo	Descripción
<b>Images (still)</b>	<b>Pre-event starting time (sec):</b> tiempo (anterior al evento real ocurrido) a la que se comienzan a mostrar imágenes estáticas. <b>Number of images:</b> número de imágenes estáticas para mostrar. <b>Interval between images (sec):</b> tiempo requerido entre cada imagen estática.
<b>Clips (video)</b>	<b>Pre-event starting time (sec):</b> tiempo (anterior al evento real ocurrido) a la que se comienza a mostrar vídeo. <b>Duration (sec):</b> duración total del clip de vídeo <b>NOTA:</b> estos campos están bloqueados actualmente y no es posible cambiar sus parámetros predeterminados.

**NOTA:** Para que se puedan grabar video clips, asegúrese de insertar una tarjeta SD y de desconectar y conectar la electricidad de la cámara.

6. Cuando haya terminado, pulse **Done**. El trigger de la cámara definido se visualizará en la página de la lista de triggers de la cámara.

## IP Cameras

Cameras
Triggers

+ Add Trigger

Label	Event	Camera	Camera Operations	Actions
Lobby floor alarm	Partition - Lobby Floor Alarm Follow	Street cam North	3 images, 10 seconds clip	
Storage Tamper	Partition - Storage Rooms Tamper Follow	Street cam South	1 image	
Lobby Arming	Detector - Lobby South-East Arm Follow	Lobby main cam	5 images, 20 seconds clip	

Duplicate

**Figura 21** Lista de triggers de la cámara

**NOTA:** también existen opciones para editar , crear un duplicado o eliminar el trigger de la cámara seleccionada.

**IMPORTANTE:** no se pueden definir dos triggers de cámara idénticos. Si se duplica un trigger de la cámara, el evento, la cámara o ambas definiciones deben modificarse.

## Configuración avanzada

Por motivos de seguridad, se han tomado medidas como la restricción del acceso a la cámara IP para minimizar los riesgos de intervención no deseada. No obstante, en algunos casos es necesario modificar la configuración predeterminada de la cámara IP según las necesidades puntuales. Esta tarea debe llevarla a cabo un instalador profesional con experiencia y permiso especial para acceder a la configuración de la cámara IP.

### Para acceder a la configuración de la cámara IP

1. Pulse el botón ... para activar la opción UI/CGI.



Figura 22 La configuración de la cámara IP

Aparecerá la siguiente pantalla.

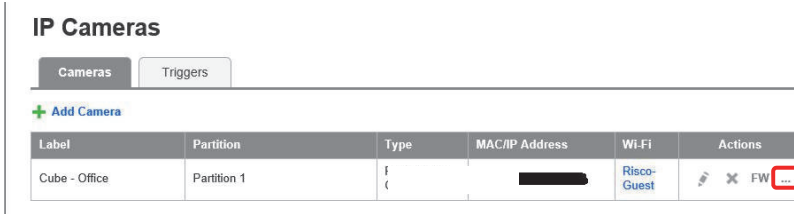

Figura 23 La casilla de verificación UI/CGI

2. Marque la casilla de verificación UI/CGI.
3. Pulse **Save**.

El instalador ahora tiene acceso a la interfaz web de la cámara IP durante una hora. Abra una ventana del navegador de Internet y escriba la dirección IP de la cámara. Por defecto, los campos de nombre de usuario y contraseña para acceder al inicio de sesión de la cámara IP son **admin** y **AdmiN\_dirección MAC de la cámara IP** (por ejemplo, **\_AdmiN\_AABBCCDDEEFF**).

---

**NOTA:** transcurrida una hora, el acceso a la cámara se desactiva.

---

## **Conectarse a un grabador de vídeo de red local (NVR)**

El instalador puede conectar la cámara IP a un NVR local. El instalador debe determinar la dirección IP de la cámara IP y configurarla como una cámara ONVIF en el NVR. Además, el instalador debe introducir las credenciales de la cámara IP. Por defecto, los campos de nombre de usuario y contraseña para acceder al inicio de sesión de la cámara IP son **admin** y **AdmiN\_dirección MAC de la cámara IP** (por ejemplo, **\_AdmiN\_AABBCCDDEEFF**). Se utilizan las mismas credenciales para la cámara ONVIF.

El instalador ahora puede acceder también a la transmisión en directo de la cámara IP.

---

**NOTA:** los cambios realizados en la configuración predeterminada de la cámara IP se realizan bajo la responsabilidad del instalador.

---

# Especificaciones del producto

<b>Modelo</b>	<b>RVCM32W0200A</b>	
<b>Camera</b>		
Sensor de imagen	1/3" CMOS de barrido progresivo 1,3 megapíxeles	
Píxeles efectivos	1280(H) x960(V)	
Sistema de barrido	Progresivo	
Velocidad de obturador electrónico	Auto/Manual, 1/3(4)~1/100000s	
Iluminación mínima	0. 1 lux/F2.0(Color), 0 lux/F2.0(IR encendido)	
Relación S/N	Más de 50 dB	
Salida de vídeo	N/A	
<b>Características de la cámara</b>		
Alcance máximo de los LED IR	30 m	
Día/Noche	Auto(ICR)/Color/B/N	
Compensación de contraluz	BLC/HLC/DWDR	
Balance de blancos	Auto/Manual	
Control de ganancia	Auto/Manual	
Reducción de ruido	3D	
Enmascaramiento de privacidad	Hasta 4 zonas	
<b>Lente</b>		
Distancia focal	3,6 mm	
Apertura máxima	F2.0 (F2.0)	
Control de enfoque	Manual	
Ángulo de visión	H: 72°(92°)	
Tipo de lente	Lente fija	
Tipo de montaje	Tipo panel	
<b>Vídeo</b>		
Compresión	H.264/H.264H/H.264B/MJPEG	
Resolución	1,3 MP(1280×960)/720P(1280×720)/VGA(640×480)/QVGA(320×240)	
Velocidad de fotogramas	Transmisión principal	1,3 MP/720P(1~25/30 fps)
	Transmisión secundaria	VGA/QVGA(1 ~ 25/30 fps)
Velocidad de bits	H.264: 32 kbps~8192 kbps	
Modo Pasillo	Soportado	
<b>Audio</b>		
Compresión	N/A	
Interfaz	N/A	

<b>Red</b>	
Ethernet	RJ-45 (10/100Base-T)
Wi-Fi	Wi-Fi(IEEE802.11b/g/n) 50 m(campo abierto)
Protocolos	P2P, IPv4/IPv6, HTTP, HTTPS, TCP/IP, UDP, UPnP, ICMP, IGMP, RTSP, RTP, SMTP, NTP, DHCP, DNS, PPPOE, DDNS, FTP, IP Filter, QoS
Compatibilidad	ONVIF, CGI
Número máximo de acceso de usuarios	20 usuarios
Dispositivos móviles	iPhone, iPad, Android
<b>Interfaz auxiliar</b>	
Ranura de memoria	Tarjeta Micro SD, hasta 128 GB
RS485	N/A
Alarma	N/A
Rango de sensor PIR	N/A
<b>General</b>	
Fuente de alimentación	12V DC
Consumo de energía	<4,6 W (IR encendido)
Frecuencia y Potencia	2412 – 2462 MHz, 0.0215 W 2422 – 2452 MHz, 0.0095 W
Entorno de funcionamiento	-30 °C~+50 °C, menos de 95% de humedad relativa
Protección frente a penetración	IP67
Resistencia vandálica	IK10
Dimensiones	Φ110 mm × 81 mm
Peso	0,55 kg con embalaje



**Contains FCC ID:2AATL-8112MET**

This device complies with part 15 of the FCC Rules. Operation is subject to the following two conditions:

- (1) This device may not cause harmful interference, and
- (2) This device must accept any interference received, including interference that may cause undesired operation

Changes or modifications to this equipment which are not expressly approved by the party responsible for compliance (RISCO Group's.) could void the user's authority to operate the equipment.

**FCC Note**

This equipment has been tested and found to comply with the limits for a Class B digital device, pursuant to part 15 of the FCC Rules.

These limits are designed to provide reasonable protection against harmful interference in a residential installation. This equipment generates uses and can radiate radio frequency energy and, if not installed and used in accordance with the instructions, may cause harmful interference to radio communications. However, there is no guarantee that interference will not occur in a particular installation. If this equipment does cause harmful interference to radio or television reception, which can be determined by turning the equipment on and off, the user is encouraged to try to correct the interference by one or more of the following measures:

- ◆ Reorient or relocate the receiving antenna.
- ◆ Increase the separation between the equipment and the receiver.
- ◆ Connect the equipment into an outlet on to a different circuit from that to which the receiver is connected.
- ◆ Consult the dealer or an experienced radio/TV technician for help.

## Standard Limited Product Warranty (“Limited Warranty”)

RISCO Ltd. (“RISCO”) guarantee RISCO’s hardware products (“Products”) to be free from defects in materials and workmanship when used and stored under normal conditions and in accordance with the instructions for use supplied by RISCO, for a period of (i) 24 months from the date of delivery of the Product ( the “Warranty Period”). This Limited Warranty covers the Product only within the country where the Product was originally purchased and only covers Products purchased as new.

**Contact with customers only.** This Limited Warranty is solely for the benefit of customers who purchased the Products directly from RISCO or from an authorized distributor of RISCO. RISCO does not warrant the Product to consumers and nothing in this Warranty obligates RISCO to accept Product returns directly from end users who purchased the Products for their own use from RISCO’s customer or from any installer of RISCO, or otherwise provide warranty or other services to any such end user directly. RISCO’s authorized distributor or installer shall handle all interactions with its end users in connection with this Limited Warranty. RISCO’s authorized distributor or installer shall make no warranties, representations, guarantees or statements to its end users or other third parties that suggest that RISCO has any warranty or service obligation to, or any contractual privity with, any recipient of a Product.

**Remedies.** In the event that a material defect in a Product is discovered and reported to RISCO during the Warranty Period, RISCO shall accept return of the defective Product in accordance with the below RMA procedure and, at its option, either (i) repair or have repaired the defective Product, or (ii) provide a replacement product to the customer.

**Return Material Authorization.** In the event that you need to return your Product for repair or replacement, RISCO will provide you with a Return Merchandise Authorization Number (RMA#) as well as return instructions. Do not return your Product without prior approval from RISCO. Any Product returned without a valid, unique RMA# will be refused and returned to the sender at the sender’s expense. The returned Product must be accompanied with a detailed description of the defect discovered (“Defect Description”) and must otherwise follow RISCO’s then-current RMA procedure published in RISCO’s website at [www.riscogroup.com](http://www.riscogroup.com) in connection with any such return. If RISCO determines in its reasonable discretion that any Product returned by customer conforms to the applicable warranty (“Non-Defective Product”), RISCO will notify the customer of such determination and will return the applicable Product to customer at customer’s expense. In addition, RISCO may propose and assess customer a charge for testing and examination of Non-Defective Product.

**Entire Liability.** The repair or replacement of Products in accordance with this Limited Warranty shall be RISCO’s entire liability and customer’s sole and exclusive remedy in case a material defect in a Product is discovered and reported as required herein. RISCO’s obligation and this Limited Warranty are contingent upon the full payment by customer for such Product and upon a proven weekly testing and examination of the Product functionality.

**Limitations.** This Limited Warranty is the only warranty made by RISCO with respect to the Products. The warranty is not transferable to any third party. To the maximum extent permitted by applicable law, this Limited Warranty shall not apply and will be void if: (i) the conditions set forth above are not met (including, but not limited to, full payment by customer for the Product and a proven weekly testing and examination of the Product functionality); (ii) if the Products or any part or component thereof: (a) have been subjected to improper operation or installation; (b) have been subject to neglect, abuse, willful damage, abnormal working conditions, failure to follow RISCO's instructions (whether oral or in writing); (c) have been misused, altered, modified or repaired without RISCO's written approval or combined with, or installed on products, or equipment of the customer or of any third party; (d) have been damaged by any factor beyond RISCO's reasonable control such as, but not limited to, power failure, electric power surges, or unsuitable third party components and the interaction of software therewith or (e) any failure or delay in the performance of the Product attributable to any means of communication provided by any third party service provider, including, but not limited to, GSM interruptions, lack of or internet outage and/or telephony failure. BATTERIES ARE EXPLICITLY EXCLUDED FROM THE WARRANTY AND RISCO SHALL NOT BE HELD RESPONSIBLE OR LIABLE IN RELATION THERETO, AND THE ONLY WARRANTY APPLICABLE THERETO, IF ANY, IS THE BATTERY MANUFACTURER'S WARRANTY. RISCO does not install or integrate the Product in the end user's security system and is therefore not responsible for and cannot guarantee the performance of the end user's security system which uses the Product or which the Product is a component of.

This Limited Warranty applies only to Products manufactured by or for RISCO. Further, this Limited Warranty does not apply to any software (including operating system) added to or provided with the Products or any third-party software, even if packaged or sold with the RISCO Product. Manufacturers, suppliers, or third parties other than RISCO may provide their own warranties, but RISCO, to the extent permitted by law and except as otherwise specifically set forth herein, provides its Products "AS IS". Software and applications distributed or made available by RISCO in conjunction with the Product (with or without the RISCO brand), including, but not limited to system software, as well as P2P services or any other service made available by RISCO in relation to the Product, are not covered under this Limited Warranty. Refer to the Terms of Service at: <https://riscocloud.com/ELAS/WebUI/UserLogin/License> for details of your rights and obligations with respect to the use of such applications, software or any service. RISCO does not represent that the Product may not be compromised or circumvented; that the Product will prevent any personal injury or property loss by burglary, robbery, fire or otherwise, or that the Product will in all cases provide adequate warning or protection. A properly installed and maintained alarm may only reduce the risk of a burglary, robbery or fire without warning, but it is not insurance or a guarantee that such will not occur or will not cause or lead to personal injury or property loss. CONSEQUENTLY, RISCO SHALL HAVE NO LIABILITY FOR ANY PERSONAL INJURY, PROPERTY DAMAGE OR OTHER LOSS BASED ON ANY CLAIM AT ALL INCLUDING A CLAIM THAT THE PRODUCT FAILED TO GIVE WARNING.

EXCEPT FOR THE WARRANTIES SET FORTH HEREIN, RISCO AND ITS LICENSORS HEREBY DISCLAIM ALL EXPRESS, IMPLIED OR STATUTORY, REPRESENTATIONS, WARRANTIES, GUARANTEES, AND CONDITIONS WITH REGARD TO THE PRODUCTS, INCLUDING BUT NOT LIMITED TO ANY REPRESENTATIONS, WARRANTIES, GUARANTEES, AND CONDITIONS OF MERCHANTABILITY, FITNESS FOR A PARTICULAR PURPOSE, TITLE AND WARRANTIES AGAINST HIDDEN OR LATENT DEFECTS, TO THE EXTENT PERMITTED BY LAW. WITHOUT LIMITING THE GENERALITY OF THE FOREGOING, RISCO AND ITS LICENSORS DO NOT REPRESENT OR WARRANT THAT: (i) THE OPERATION OR USE OF THE PRODUCT WILL BE TIMELY, SECURE, UNINTERRUPTED OR ERROR-FREE; (ii) THAT ANY FILES, CONTENT OR INFORMATION OF ANY KIND THAT MAY BE ACCESSED THROUGH THE PRODUCT SHALL REMAIN SECURED OR NON DAMAGED. CUSTOMER ACKNOWLEDGES THAT NEITHER RISCO NOR ITS LICENSORS CONTROL THE TRANSFER OF DATA OVER COMMUNICATIONS FACILITIES, INCLUDING THE INTERNET, GSM OR OTHER MEANS OF COMMUNICATIONS AND THAT RISCO'S PRODUCTS, MAY BE SUBJECT TO LIMITATIONS, DELAYS, AND OTHER PROBLEMS INHERENT IN THE USE OF SUCH MEANS OF COMMUNICATIONS. RISCO IS NOT RESPONSIBLE FOR ANY DELAYS, DELIVERY FAILURES, OR OTHER DAMAGE RESULTING FROM SUCH PROBLEMS. RISCO WARRANTS THAT ITS PRODUCTS DO NOT, TO THE BEST OF ITS KNOWLEDGE, INFRINGE UPON ANY PATENT, COPYRIGHT, TRADEMARK, TRADE SECRET OR OTHER INTELLECTUAL PROPERTY RIGHT IN ANY EVENT RISCO SHALL NOT BE LIABLE FOR ANY AMOUNTS REPRESENTING LOST REVENUES OR PROFITS, PUNITIVE DAMAGES, OR FOR ANY OTHER INDIRECT, SPECIAL, INCIDENTAL, OR CONSEQUENTIAL DAMAGES, EVEN IF THEY WERE FORESEEABLE OR RISCO HAS BEEN INFORMED OF THEIR POTENTIAL

### **RED Statement**

Hereby, RISCO Group declares that this equipment is in compliance with the essential requirements and other relevant provisions of Directive 2014/53/EU. For the CE Declaration of Conformity please refer to our website: [www.riscogroup.com](http://www.riscogroup.com)

### **Contacting RISCO**

RISCO Group is committed to customer service and Product support. You can contact us through our website ([www.riscogroup.com](http://www.riscogroup.com)) or at the following telephone and fax numbers:

#### **United Kingdom**

Tel: +44-(0)-161-655-5500  
[support-uk@riscogroup.com](mailto:support-uk@riscogroup.com)

#### **Italy**

Tel: +39-02-66590054  
[support-it@riscogroup.com](mailto:support-it@riscogroup.com)

#### **Spain**

Tel: +34-91-490-2133  
[support-es@riscogroup.com](mailto:support-es@riscogroup.com)

#### **France**

Tel: +33-164-73-28-50  
[support-fr@riscogroup.com](mailto:support-fr@riscogroup.com)

#### **Belgium (Benelux)**

Tel: +32-2522-7622  
[support-be@riscogroup.com](mailto:support-be@riscogroup.com)

#### **USA**

Tel: +1-631-719-4400  
[support-usa@riscogroup.com](mailto:support-usa@riscogroup.com)

#### **China**

Tel: +86-755-82789285  
[support-cn@riscogroup.com](mailto:support-cn@riscogroup.com)

#### **Israel**

Tel: +972-3-963-7777  
[support@riscogroup.com](mailto:support@riscogroup.com)

All rights reserved.

No part of this document may be reproduced in any form without prior written permission from the publisher.